

# S c a n P l u s Reference Manual

**Edition 1.0**

April 1996

SP/XX/RM/10/E/960401

## Notice

The ScanPlus products described in this manual comply with CE directives for electromagnetic emission levels and electrical immunity.

The information contained in this manual is for informational purposes only and is subject to change without notice. No part of this manual may be copied or reproduced in any manner without the prior written permission of United Barcode Industries.

ScanPlus products are covered by patents issued or pending in the USA and other countries. ScanPlus is a trademark of United Barcode Industries.

This Reference Manual can be used with all ScanPlus products except the ScanPlus CL.

# Contents

---

The topics in this manual are presented in alphabetical order for easy access. Use the *Contents* for a quick overview if you do not know where to find a particular item.

ASCII character codes.....	1
Beeps / green indicator LED.....	14
Power-up beeps / power-up LED.....	14
Good read beeps / good read LED.....	15
Crackles, beeps and LEDs—2D bar codes.....	17
Configuration beeps.....	19
Software/CPU version beeps and flashes.....	19
Code mark.....	20
Default code marks.....	20
Composing custom code marks.....	21
AIM symbology identifiers.....	23
Compose interface number.....	25
Which interface number?.....	25
Composing an interface number.....	25
Concatenating configuration bar codes.....	27
What is a configuration bar code?.....	27
Why concatenate?.....	27
Limitations.....	27
How to concatenate.....	27
Configuration modes.....	29
Configuration authorization modes.....	29
Temporary configuration mode.....	30
Transparent configuration mode.....	31

# Contents

Display data string mode .....	32
Data decoding security parameters .....	33
Description .....	33
Predefined security levels .....	34
Consecutive same read data validation .....	35
Time-out between identical consecutive codes .....	36
Time-out between different consecutive codes .....	37
Default parameter settings .....	38
Emulating special keyboard keys—Keyboard wedge .....	39
Interpreting and transmitting special keyboard keys .....	39
Special keys interpretation codes .....	40
Special keys transmission codes .....	42
Flashing mode .....	43
Glossary .....	44
IBM 46xx cash registers .....	45
Connection .....	45
Predefined interface numbers .....	46
Predefined data transmission settings .....	47
Transmission delay .....	47
Installation procedure .....	48
General installation / configuration procedure .....	48
Inter-character delay .....	49
Predefined delay values .....	49
Compose inter-character delay .....	49
Inter-message delay .....	51
Predefined delay values .....	51
Compose inter-message delay .....	51
Interfaces .....	53
Interface types .....	53

## Contents

Identifying the interface .....	53
Keyboard wedge.....	54
Connection .....	54
Predefined interface numbers .....	55
Predefined data transmission settings .....	59
Preamble / postamble.....	60
Interpreting and transmitting special keyboard keys .....	62
End-of-transmission keyboard character status .....	62
Transmission delay .....	62
Keyboard wedge—Additional preamble / postamble characters .....	63
Laser emulation .....	68
Connection .....	68
Predefined interface numbers .....	69
Predefined data transmission settings .....	70
Transmitted symbology type .....	71
Transmission delay .....	71
Margin size .....	72
Logical output signal state .....	73
Number codes .....	75
OCIA cash registers .....	76
Connection .....	76
Predefined interface numbers .....	77
Predefined data transmission settings .....	78
Transmission delay .....	78
Parameter list / data strings .....	79
Interface numbers.....	79
Data transmission parameters .....	82
Symbology parameters.....	88
ScanPlus operating parameters .....	94
Data string values .....	98

# Contents

Preamble / postamble .....	105
Product checklist.....	106
Pushbutton models .....	107
Standard pushbutton models .....	107
Energy saver pushbutton models .....	108
Pushbutton models—Activation .....	109
Pushbutton deactivation.....	109
Pushbutton activation.....	109
Pushbutton operating scenarios .....	110
Standard pushbutton models .....	112
Energy saver pushbutton models .....	114
Compose read duration .....	115
Reset all configuration parameters .....	116
Reset factory defaults .....	116
RS-232.....	117
Direct connection .....	117
Single-output connection—External power supply.....	118
Dual-output connection .....	120
Predefined interface numbers .....	122
Predefined data transmission settings .....	123
Baud Rate.....	124
Data bits.....	125
Parity.....	125
Stop bits .....	125
ENQ / ACK / NAK software protocol .....	126
XON/XOFF software protocol .....	128
CTS/RTS hardware protocol .....	128
LRC (Longitudinal Redundancy Check) .....	129
Time-out (hardware and software) .....	129
Preamble / postamble .....	130
Transmission delay .....	131

# Contents

- RS-232—Slave mode ..... 132
  - Activation ..... 132
  - How to use slave mode ..... 132
- Scan rate parameters—ScanPlus SP ..... 134
  - Predefined scan rates ..... 134
  - Scan rate / decode rate ratio ..... 135
- Software / CPU version identification ..... 136
  - Software / CPU Versions ..... 136
  - Version indications ..... 136
- Symbologies ..... 138
  - Available symbologies ..... 138
  - Default symbologies ..... 138
  - Character formats and ScanPlus transmission format ..... 139
  - Barcode length and data security ..... 139
- Symbologies—Activation ..... 142
- Symbologies—Codabar ..... 146
  - Activation ..... 146
  - Default values ..... 146
  - Start/stop ..... 147
  - CLSI library system ..... 147
  - Check digit (AIM recommendation) ..... 148
  - Barcode length ..... 150
- Symbologies—Codablock ..... 151
  - Activation ..... 151
  - Default values ..... 151
  - Time-out between reads ..... 152
  - Check digit ..... 152
- Symbologies—Code 39 ..... 153
  - Activation ..... 153
  - Default values ..... 153

## Contents

Start/stop.....	155
Check digit .....	156
Barcode length.....	157
Special wedge keys emulation.....	157
Symbologies—Code 93 .....	158
Activation .....	158
Default values .....	158
Barcode length.....	159
Symbologies—Code 128 / EAN 128.....	160
Activation .....	160
Default values .....	160
Barcode length.....	161
Code EAN-128 norms (auto-discriminating) .....	162
Symbologies—EAN-8, EAN-13.....	163
Symbologies—EAN 128 .....	164
Symbologies—Interleaved 2 of 5 .....	165
Activation .....	165
Default values .....	165
Check digit .....	166
Barcode length.....	167
Symbologies—Matrix 2 of 5 .....	168
Activation .....	168
Default values .....	168
Barcode length.....	169
Symbologies—MSI Code.....	170
Activation .....	170
Default values .....	170
Check digit .....	170
Barcode length.....	171
Symbologies—PDF417 .....	172

# Contents

- Activation ..... 172
- Symbologies—Plessey Code ..... 173
  - Activation ..... 173
  - Default values ..... 173
  - Check digit ..... 173
  - Barcode length ..... 174
- Symbologies—Standard 2 of 5 ..... 175
  - Activation ..... 175
  - Default values ..... 175
  - Check digit mod 10 ..... 176
  - Barcode length ..... 177
- Symbologies—UPC/EAN code families ..... 178
  - Activation ..... 178
  - Default values ..... 179
  - Add-on digits ..... 180
  - Check digit ..... 181
  - Transmission of number system ..... 182
  - Re-encoding UPC-A, UPC-E, EAN-8 ..... 183
- Test codes ..... 184
  - One-dimensional symbologies ..... 184
  - Two-dimensional symbologies ..... 185
- Troubleshooting ..... 186
  - Before you contact your UBI representative . . . ..... 186
  - If you still have a problem . . . ..... 186
  - Power-up problems—all models ..... 187
  - Operating problems—all models ..... 188
  - Operating problems—pushbutton models ..... 189
  - Configuration problems—all models ..... 190
- Wand emulation ..... 191
  - Connection ..... 191

## Contents

Predefined interface numbers .....	192
Predefined data transmission settings .....	193
Transmitted symbology type .....	194
Transmission delay .....	194
Margin size.....	195
Logical output signal state .....	196
Pulse duration .....	198

# ASCII character codes

---

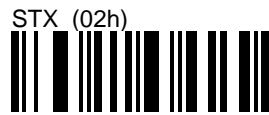

## ASCII character codes

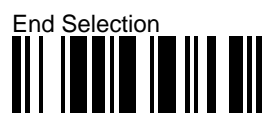
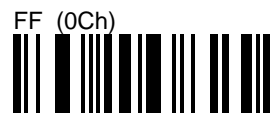
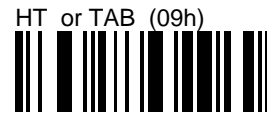

## ASCII character codes

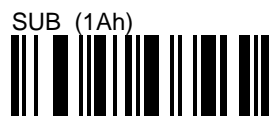
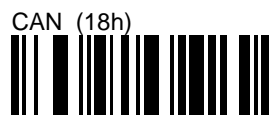
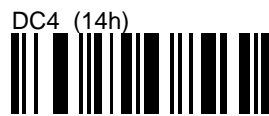
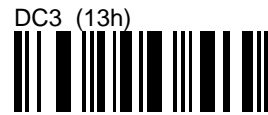
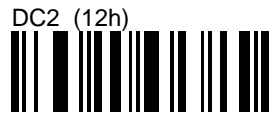

## ASCII character codes

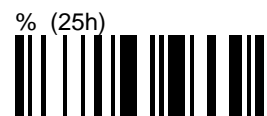
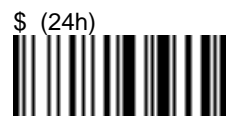
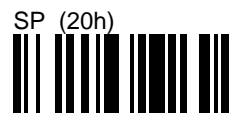

## ASCII character codes

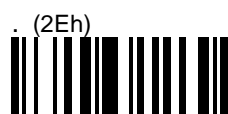
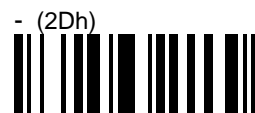
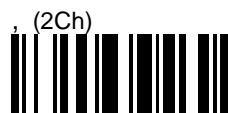
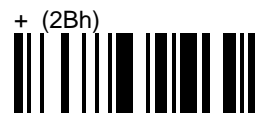
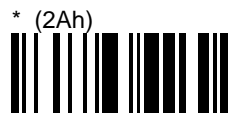
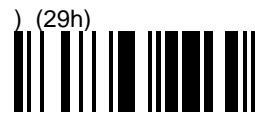

## ASCII character codes

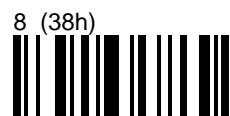
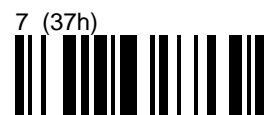
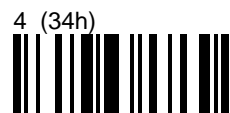
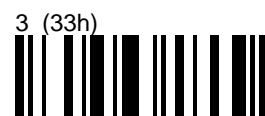
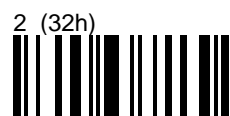
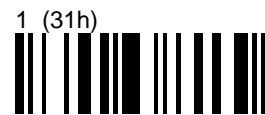

## ASCII character codes



## ASCII character codes

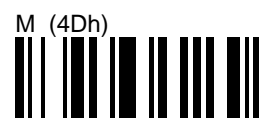
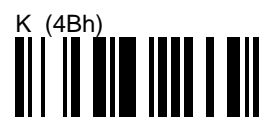
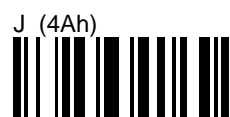
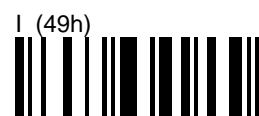

## ASCII character codes

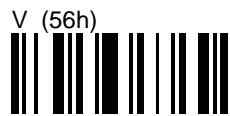
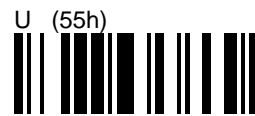
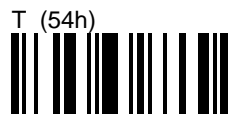
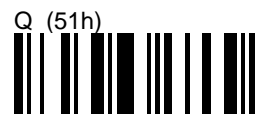
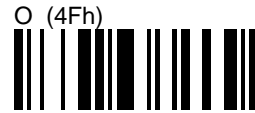
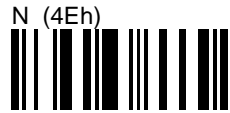

## ASCII character codes

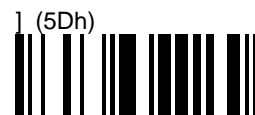
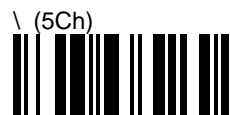
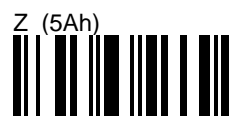

## ASCII character codes

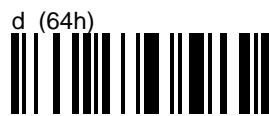

## ASCII character codes

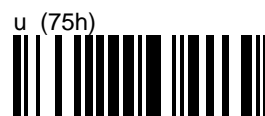
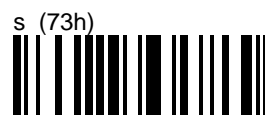

## ASCII character codes

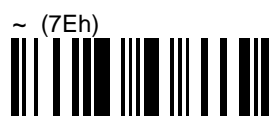

## Beeps / green indicator LED

# Beeps / green indicator LED

---

### Power-up beeps / power-up LED

Two beeps indicate that the power-up sequence has been completed.

Three long beeps followed by five short beeps indicate an EEPROM integrity error at power-up. If this occurs, contact your UBI representative.

**If you have an energy saver pushbutton model and the pushbutton is activated, the power-up beeps and power-up LED are deactivated and can not be activated.**

Power-Up Beeps / Power-Up LED On (\*)



Power-Up Beeps / Power-Up LED Off



### Identifying the interface

After the two power-up beeps, the number of green indicator LED flashes at power-up indicates the interface driver selected for your ScanPlus.

The Part Number (P/N) indicates the hardware interface setup for your ScanPlus model.

green LED indication	selected interface type	P/N identification
continuous LED	null interface	factory default setting (all models)
no LED	laser emulation	x - x x x x x 0 - x x - x x
1 flash	wand emulation	x - x x x x x 1 - x x - x x
2 flashes	RS-232 C	x - x x x x x 2 - x x - x x
3 flashes	IBM 46xx cash registers	x - x x x x x 3 - x x - x x
4 flashes	RS-232 TTL	x - x x x x x 4 - x x - x x
5 flashes	OCIA cash registers	x - x x x x x 5 - x x - x x
7 flashes	keyboard wedge	x - x x x x x 7 - x x - x x

## Beeps / green indicator LED

### Good read beeps / good read LED

By default, a single short beep (80 ms) indicates that the barcode has been read successfully.

If Beep After Transmission is selected, the same beep indicates that the bar code has been read and transmitted to the host system.

### Number of good read beeps

1 Good Read Beep (\*)



2 Good Read Beeps



No Good Read Beep



### Timing of good read beeps

Beep Before Transmission (\*)



Beep After Transmission



## Beeps / green indicator LED

### Duration of good read beeps

80 ms Beep Duration (\*)



60 ms Beep Duration



200 ms Beep Duration



300 ms Beep Duration



### Compose good read beep duration

Compose Beep Duration (0 to 999 ms)



Example To make each beep last for half a second (500 ms):

1. Scan Compose Beep Duration.
2. Scan 5 0 0 then scan End Selection (→ *Number codes* or inside back cover of this manual).

### Good read LED

Good Read LED On (\*)



Good Read LED Off



## Beeps / green indicator LED

### Crackles, beeps and LEDs—2D bar codes

#### 2D crackle / LED flicker



#### Reading Codablock bar codes—ScanPlus XP / ScanPlus PDF

irregular crackle 

The ScanPlus XP / ScanPlus PDF is reading Codablock data—the more intensive the crackle, the better the reading performance. If LED Flicker On is selected, the green indicator LED will also flicker. The crackling and flickering continue all the time the ScanPlus is reading.

single clear success beep 

The ScanPlus XP / ScanPlus PDF has successfully read the code.

If the ScanPlus is removed from the Codablock code for more than 10 seconds before you finish reading the code (before you hear a success beep), the data you have read so far will be lost and you will have to start again.

## Beeps / green indicator LED

### Reading PDF417 bar codes—ScanPlus PDF

irregular crackle 

The ScanPlus PDF is reading new PDF417 data—the more intensive the crackle, the better the reading performance. If LED Flicker On is selected, the green indicator LED will also flicker.

regular tick 

The ScanPlus PDF has already read the data you are scanning—you will hear this if you have to rescan the same area of code a second time or if you pause over the code during scanning.

regular continuous crackle 

The ScanPlus PDF has read all the data and is doing error-correction processing—you will hear this with codes with a high security level or if the code is of poor quality.

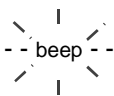
single clear success beep 

The ScanPlus PDF has successfully read the code.

If the ScanPlus is removed from the PDF417 code for more than 10 seconds before you finish reading the code (before you hear a success beep), the data you have read so far will be lost and you will have to start again.

## Beeps / green indicator LED

### Configuration beeps

The ScanPlus has special beeps for the configuration bar codes provided in this manual.

**success** A short beep followed by a long beep indicates the selection has been accepted by the ScanPlus.

**error** Six short beeps indicate a setup error (incorrect configuration code) for the selected interface type:

- option not available,
- interface number not available,
- optional feature not implemented,
- commands not read in the correct order,
- other setup errors.

Three long beeps indicate an EEPROM hardware error during configuration. If this occurs, contact your UBI representative.

### Software/CPU version beeps and flashes

Recent ScanPlus models produce software version identification beeps and CPU version LED flashes (red reading LEDs) when you read the Software / CPU Versions code (→ *Software/CPU version identification*).

## Code mark

# Code mark

---

### Default code marks

Code Mark Transmitted enables transmission of current settings of code marks—barcode symbology identifying characters.

Code marks are transmitted after the preamble if present and before the barcode data.

 **Code marks should only be activated for keyboard wedge and RS-232 interfaces.**

Code Mark Not Transmitted (\*)



Code Mark Transmitted



### Default code mark values

symbology	default code mark
Codablock A	*
Codablock F	*
Codabar	D
Code 39	*
Code 93	D
Code 128 / EAN 128	D
Interleaved 2 of 5	I
Matrix 2 of 5	D
Standard 2 of 5	D
PDF417	*
MSI Code	D
Plessey Code	D
UPC-A	F
UPC-E	E
EAN-8	FF
EAN-13	F

## Composing custom code marks

1. Select the Compose Code Mark code for your symbology.
2. Scan an identifying character and scan End Selection ( → *ASCII character codes*).

 **Scanning any Compose Code Mark code automatically activates code mark transmission for all symbologies (use for keyboard wedge and RS-232 interfaces only).**

Codablock A—Compose Code Mark



Codablock F—Compose Code Mark



Codabar—Compose Code Mark



Code 39—Compose Code Mark



Code 93—Compose Code Mark



Code 128 / EAN 128—Compose Code Mark



Interleaved 2 of 5—Compose Code Mark



Matrix 2 of 5—Compose Code Mark



## Code mark

Standard 2 of 5—Compose Code Mark



PDF417—Compose Code Mark



MSI Code—Compose Code Mark



Plessey Code—Compose Code Mark



UPC-A—Compose Code Mark



UPC-E—Compose Code Mark



EAN-8—Compose Code Mark



EAN-13—Compose Code Mark



## AIM symbology identifiers

AIM symbology identifiers are optional 3-character code marks that have been standardized by the AIM Committee.

AIM symbology identifiers are transmitted after the preamble if present and before the barcode data.

**Selecting AIM Transmitted automatically activates AIM symbology identifier transmission for all symbologies.**

 **AIM symbology identifiers should only be activated for keyboard wedge and RS-232 interfaces.**



### Identifier syntax

AIM symbology identifiers consist of 3 characters which provide the following information:

- the character " ] " indicates that the input source type is a bar code,
- a letter (A, B, C, . . . ) identifies the symbology,
- a hexadecimal number identifies any special processing performed by the ScanPlus.

**Example** If you select AIM Transmitted, a standard Code 39 code without check digit and containing the string CODE-39 will be transmitted as follows:

]A0CODE-39

The table on the next page provides the list of symbology identifiers and processing options supported.

## Code mark

### AIM symbology identifiers / supported processing options

Not all the special processing options are supported.  
Refer to the official AIM documentation on symbology identifiers for full information on the different processing options.

<b>symbology</b>	<b>AIM symbology identifier</b>	<b>AIM processing options</b>
Codablock A	O	6
Codablock F	O	4
Codabar	F	0, 2, 4
Code 39	A	0, 1, 2, 4
Code 93	G	0
Code 128 / EAN 128	C	0, 1
Interleaved 2 of 5	I	0, 1, 2
Matrix 2 of 5	X	0
Standard 2 of 5	S	0, 1, 2
PDF417	L	0
MSI Code	M	0, 1
Plessey Code	P	0
UPC/EAN, "standard" lengths (8, 13, 15 (add-on 2), 18 (add-on 5) characters)	E	0, 3, 4
UPC/EAN, other lengths (no check digit, . . .)	X	0

## Compose interface number

---

### Which interface number?

To know which interface number to enter, check the following points in the order shown:

1. Look to see if there is a suitable number in the *Predefined interface numbers* section for your interface.
2. Look to see if your configuration is described in the *ScanPlus Terminal List* (if available).
3. If you still do not know which number to enter, contact your UBI representative.

Entering an interface number usually only modifies data transmission parameter settings but in some special cases, other parameter settings (pushbutton activation, indicator LED / beep settings, symbologies, etc.) may be modified for specific interface configurations.

 **Do not enter an interface number that is not compatible with the interface-specific software and hardware configuration of your ScanPlus model—check the ScanPlus Part Number if you do not know the interface for your model (→ *Interfaces*).**

### Composing an interface number

Example To enter the number 102:

1. Scan Compose Interface Number on the next page.
2. Scan each digit of your interface number using the number codes—in our example we would scan 1, then 0, then 2.
3. Scan End Selection to finish.

## Compose interface number

Compose Interface Number



End Selection

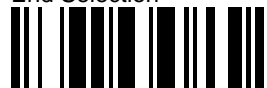

# Concatenating configuration bar codes

---

### What is a configuration bar code?

All the configuration codes in this Reference Manual are Code 128 bar codes with a special terminator character—FNC3, data string \60—to indicate that the code is a configuration code.

### Why concatenate?

In order to configure the ScanPlus for a given installation, you may need to read a number of configuration codes one after the other—and you may need to do this for each ScanPlus you have to install and set up.

Many of the configuration bar codes in this manual can be concatenated (combined) to form a single custom bar code which corresponds to your own particular setup configuration—you then only need to read 1 or 2 concatenated codes instead of a whole series of codes.

### Limitations

**Do not create concatenated codes wider than the maximum reading width of your ScanPlus product (71 mm (2.80") for the ScanPlus SP for example).**

**If you need to create more than one code for a series of configuration codes, always end each concatenated code with a complete configuration code—not a partial code—and the FNC3 terminator.**

**You can not concatenate configuration codes that use the *Number codes* to compose numerical values.**

### How to concatenate

1. Identify the list of codes you want to concatenate and the order of concatenation—the codes should be concatenated in the same order as you would read them individually.

**Example** If you need to enter Reset Factory Defaults, put this code at the beginning.

## Concatenating configuration bar codes

2. Obtain the data strings for the codes you want to concatenate (→ *Parameter list / data strings*).

Example	For the following codes, you will obtain the following strings:	
	reset factory defaults	\46\42\60
	N° 201 AZERTY - French	\41\4A\03\09\60
	Codabar active	\41\52\60
	2 good read beeps	\45\4A\01\60

You can also obtain the data strings by putting the ScanPlus into Display Data String mode and reading the configuration codes of your choice (→ *Configuration modes—Display data strings*). However, the strings displayed include a check digit after the \60 end-of-code character which you must also remove when you concatenate the codes.

3. Use the individual data strings to create a single data string and remove the \60 end-of-code characters for each code except the last code in the string.

Example	For the codes listed in the previous example, you will obtain the following concatenated string:  <code>\46\42\41\4A\03\09\41\52\45\4A\01\60</code>
---------	---

4. If necessary, convert the hexadecimal values and backslash separators into suitable values for your barcode printing software (ASCII values for example).

The data strings contain hexadecimal values separated by backslashes.

**Make sure that the values you use with your software correspond to these values.**

Example: Instead of the hexadecimal value \41, you may need to use the equivalent ASCII character "A" (do not use the decimal value 41 !).

# Configuration modes

## Configuration authorization modes

### Configuration enable mode

Configuration Enable Mode allows you to configure your ScanPlus at all times.

Configuration Enable Mode (\*)



### Configuration inhibit after 1 mn

Configuration Inhibit After 1 mn protects the ScanPlus from unintentional configuration actions—configuration is inhibited if no configuration codes are read during the first minute after power-up.

Each time a configuration code is read within 1 minute, configuration is enabled for another minute.

**Configuration Inhibit After 1 mn is not available with ScanPlus pushbutton models.**

Configuration Inhibit After 1 mn

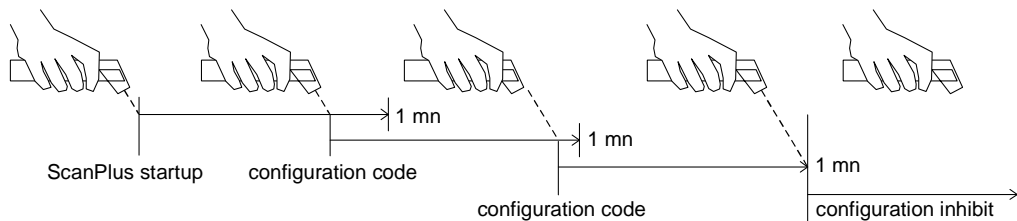

## Configuration modes

### Temporary configuration mode

Temporary Configuration Mode allows you to test new configuration settings without losing your current configuration setup.

Temporary configuration mode remains active until you select Restore/Update Current Configuration or until you switch off the ScanPlus.

Temporary Configuration Mode



### Restore current configuration

Restore Current Configuration quits temporary configuration mode and returns the ScanPlus to its current configuration settings.

Restore Current Configuration



### Update current configuration

Update Current Configuration replaces the current configuration settings with the new settings entered in temporary configuration mode.

The ScanPlus quits temporary configuration mode.

Update Current Configuration



## Configuration modes

### Transparent configuration mode

Transparent Configuration Mode allows you to use the ScanPlus (and the present Reference Manual if required!) to configure other UBI products.

**Transparent configuration mode remains active until you switch off the ScanPlus.**

Transparent Configuration Mode



- Example To use your ScanPlus to configure UBI's Omnimage product:
1. Connect the ScanPlus to the Omnimage in wand emulation mode (Wand/Magstripe connector of the Omnimage).
  2. Scan Transparent Configuration Mode.
  3. Use your ScanPlus to scan the desired configuration codes for interpretation by the Omnimage.
  4. Switch off the ScanPlus to deactivate Transparent Configuration Mode.

## Configuration modes

### Display data string mode

Display Data String Mode allows you to display the data string values and checksum for configuration bar codes on a terminal screen. The configuration codes in this manual are in Code 128 format.

Data string values are displayed in hexadecimal and are separated by backslashes.

Data string values are useful if you want to concatenate configuration bar codes (→ *Concatenating configuration bar codes*) or if you want to send commands directly from the host terminal to the ScanPlus in RS-232 Slave Mode (→ *RS-232—Slave mode*).

**Display Data String Mode remains active until you switch off the ScanPlus.**

Display Data String Mode



- Example
1. Scan Display Data String Mode.
  2. Read a configuration bar code—the Code 39 activation code (→ *Symbologies—Code 39*) for example.

The following data string will be displayed on your terminal screen:

```
\41\4C\60\5E
```

In this example, "\41\4C\60" is the command for Code 39 activation and "\5E" is the checksum.

# Data decoding security parameters

---

### Description

Data decoding security parameters allow you to ensure that the ScanPlus transmits the correct data after decoding, whatever the reading conditions or quality of the bar codes read.

### Predefined security levels

The Normal Security Level optimizes the reading speed for most situations.

Only select Medium and High Security Levels when using poor-quality bar codes or for critical applications.

The predefined security level parameters can be modified individually.

**Increasing the level of security reduces the reading speed.**

### Data security and barcode length

The reliability of the barcode data transmitted can depend on the symbologies used—some symbologies are more "fragile" than others and errors may occur due to incorrect interpretation of code lengths.

You can configure the ScanPlus to transmit data for codes of 1 or 2 fixed lengths only or codes with a known minimum length (→ *Symbologies - Barcode length and data security*).

If you use the Compose Minimum Length option, we recommend that you use a check digit and the *Consecutive same read data validation* feature provided below to ensure that the same read result is obtained on 2 or more successive reads before the read is validated.

## Data decoding security parameters

### Predefined security levels

#### Normal security level

Single Read Before Transmission—300 ms Between Identical Consecutive Codes—  
No Time-Out Between Different Consecutive Codes

Normal Security Level (\*)



#### Medium security level

2 Consecutive Same Reads Before Transmission—300 ms Between Identical Consecutive  
Codes—10 ms Between Different Consecutive Codes

Medium Security Level



#### High security level

4 Consecutive Same Reads Before Transmission—350 ms Between Identical Consecutive  
Codes—30 ms Between Different Consecutive Codes

High Security Level



## Data decoding security parameters

### Consecutive same read data validation

By default, transmission occurs after a single successful read.

Single Read Before Transmission (\*)



### Compose number of consecutive same reads before transmission

To increase the reliability of the data transmitted, you can set the ScanPlus to validate the data before transmission—it will only transmit data after a specified number of successful consecutive reads have given the same result.

Consecutive same read data validation is useful when increased data security is required—poorly printed codes, codes with variable lengths and without check digits, "fragile" barcode types.

**Increasing the number of consecutive same reads before transmission decreases the decoding rate.**

Compose Number of Consecutive Same Reads  
Before Transmission (maximum = 10)



**Example** To make your ScanPlus read the same code successfully 5 times before it can transmit it:

1. Scan Compose Number of Consecutive Same Reads.
2. Scan 5 then scan End Selection (→ *Number codes* or inside back cover of this manual).

## Data decoding security parameters

### Time-out between identical consecutive codes

By default, you can only read identical consecutive codes after a time-out between reads of 300 ms.

300 ms Between Identical Consecutive Codes (\*)



### Compose timeout between identical consecutive codes

Increasing the timeout before you can read another identical code protects against unwanted reading of the same bar code.

**This time-out should not be shorter than the Timeout Between Different Consecutive Codes.**

Compose Timeout Between Identical Consecutive Codes  
(maximum time-out = 2550 ms)



**Example** To make your ScanPlus wait 1 second (= 1000 ms) before it can read the same code again:

1. Scan Compose Timeout Between Identical Consecutive Codes.
2. Scan 1 0 0 0 then scan End Selection (→ *Number codes* or inside back cover of this manual).

## Data decoding security parameters

### Time-out between different consecutive codes

By default, you can read two different codes immediately one after the other—there is no time-out between reads.

No Time-Out Between Different Consecutive Codes (\*)



### Compose timeout between different consecutive codes

Increasing the timeout before you can read a different code protects against unwanted reading of other bar codes if they are close together on the same label.

**This time-out should not be longer than the Timeout Between Identical Consecutive Codes.**

Compose Timeout Between Different Consecutive Codes  
(maximum time-out = 2550 ms)



**Example** To make your ScanPlus wait 1 second (= 1000 ms) before it can read a different code:

1. Scan Compose Timeout Between Different Consecutive Codes.
2. Scan 1 0 0 0 then scan End Selection (→ *Number codes* or inside back cover of this manual).

## Default parameter settings

# Default parameter settings

---

Use the Reset Factory Defaults code to reset all the ScanPlus parameters to their factory default settings (→ *Reset all configuration parameters*).

→ *Parameter list / data strings* provides the full list of parameters including default settings.

# Emulating special keyboard keys— Keyboard wedge

---

## Interpreting and transmitting special keyboard keys

Different symbologies support different character formats. The ScanPlus transmission format is different according to the symbologies used (→ *Symbologies - Character formats and ScanPlus transmission format*).

Only symbologies supporting the full ASCII character set allow the encoding of certain special keyboard keys such as <Return> and <Tab>.

No symbologies support the encoding of other function keys such as <PF1> and <PageDown>.

The *Special keys interpretation* codes provided below allow you to interpret different Code 39 character combinations as special keyboard keys.

The *Special keys transmission* codes allow you to transmit certain special keyboard keys directly as a single keyboard character instead of a <Ctrl> *character* combination.

### Example

code read	interpreted as	transmitted as
(Code 39 code) x x x x x . L x x x	x x x x x . L x x x	x x x x x . L x x x
	<i>Special keys interpretation</i> x x x x x <Backspace> x x x	<i>Special keys transmission</i> x x x x x <Ctrl> H x x x
(full ASCII symbology code) x x x x x <Backspace> x x x	x x x x x <Backspace> x x x	or x x x x x <Backspace> x x x

## Emulating special keyboard keys—Keyboard wedge

### Special keys interpretation codes

The following codes allow the emulation of special keyboard keys by reading Code 39 bar codes containing dual-character combinations as shown in the *Code 39 keyboard emulation chart* on the next page.

**As the dual-character combinations use Code 39 bar codes, the ScanPlus must be enabled to read Code 39 codes with the appropriate barcode length setting (→ *Symbologies—Code 39*).**

1 - Not Active (\*)



2 - Always Active



3 - Only Active If Separate 2-Character Label  
Or If Preceded By A Hyphen ( - )



4 - Only Active If  
Separate 2-Character Label

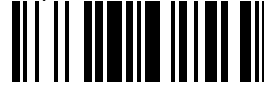

Example	original Code 39 bar code with . L dual characters (<Backspace>)	interpreted and transmitted as:
	code39.L12	1 - not activeCODE39.L12 2 - <b>always activeCODE312</b> 3 - separate 2 characters or hyphenCODE39.L12 4 - separate 2 charsCODE39.L12
	code39-.L12	1 - not activeCODE39-.L12 2 - <b>always activeCODE3912</b> 3 - <b>separate 2 chars or hyphenCODE312</b> 4 - separate 2 charsCODE39-.L12
	--.L	1 - not active--.L 2 - <b>always active-</b> 3 - <b>separate 2 chars or hyphen</b> 4 - separate 2 chars--.L
	.L	1 - not active.L 2 - <b>always activ</b> 3 - <b>separate 2 chars or hyphe</b> 4 - <b>separate 2 char</b>

## Emulating special keyboard keys—Keyboard wedge

**Code 39 keyboard emulation chart**

emulated keys	character combination	emulated keys	character combination
DEL	.A	PF1	0A
ENTER	.B	PF2	0B
RETURN	.C	PF3	0C
SEND	.D	PF4	0D
FIELD +	.E	PF5	0E
FIELD EXIT	.F	PF6	0F
HOME	.G	PF7	0G
END	.H	PF8	0H
TAB	.I	PF9	0I
ALT	.J	PF10	0J
BACK TAB	.K	PF11	0K
BACK SPACE	.L	PF12	0L
⇒	.M	PF13	0M
←	.N	PF14	0N
↑	.O	PF15	0O
↓	.P	PF16	0P
CLEAR	.Q	PF17	0Q
FIELD -	.R	PF18	0R
DUP	.S	PF19	0S
ESC	.T	PF20	0T
LINE FEED	.U	PF21	0U
RESET	.V	PF22	0V
CTRL	.W	PF23	0W
SPECIAL	.X	PF24	0X

## Emulating special keyboard keys—Keyboard wedge

### Special keys transmission codes

#### Control characters transmission

Control Characters On transmits ASCII characters for decimal numbers 1 to 27 with the sequence `<Ctrl> character`.

Control Characters Off transmits the following characters directly as single keyboard characters—useful for applications that already use the control sequences as commands:

- ASCII character 8 transmitted as `<Backspace>` instead of `<Ctrl> H`
- ASCII character 9 transmitted as `<Tab>` instead of `<Ctrl> I`
- ASCII character 27 transmitted as `<Escape>` instead of `<Ctrl> [`

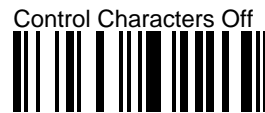

Example     `xxx <Tab> xx` (Code 128) is transmitted as:

`xxx <Ctrl> I xx`     (Control Characters On)

`xxx <Tab> xx`     (Control Characters Off)

#### Alt mode transmission

Alt Mode On emulates the [`<Alt>+decimal_number_sequence`] function available on PC AT keyboards and can be used to transmit ASCII characters that are not available on the keyboard corresponding to your interface number.

If you read bar codes containing such characters, you will be able to transmit the characters if you select Alt Mode On. Only use Alt mode if necessary, as all characters will be transmitted as `<Alt>` sequences and transmission will be slightly slower.



## Flashing mode

---

To increase LED life, the ScanPlus is configured by default to flash after 10 minutes in standby instead of producing a continuous beam. When you present a bar code, it will return to a continuous beam.

**Flashing mode is the default mode for all ScanPlus models but is not available when the pushbutton of pushbutton models is activated.**

Flash After 10 Minutes (\*)



No Flash



### Compose flash time-out

Compose Time-Out Before Flash  
(1-minute increments, max = 60 minutes)



- Example To make your ScanPlus start to flash after 30 minutes of inactivity:
1. Scan Compose Time-Out Before Flash.
  2. Scan 3 0 then scan End Selection (→ *Number codes* or inside back cover of this manual).

## Glossary

# Glossary

---

<i>aiming beam</i>	red light used to ensure that ScanPlus pushbutton models are correctly positioned over the bar codes before reading is activated—particularly useful for distance readers like the ScanPlus ER
<i>CMM</i>	Cable Management Module—cable adapter used to connect the ScanPlus to the host system if a direct connection is not possible (need for an external power supply, keyboard wedge configuration, ...)
<i>data transmission parameters</i>	interface-specific communication parameters—in certain cases they need to be modified to optimize the performance of the ScanPlus
<i>dual-output RS-232 CMM</i>	CMM for ScanPlus connected between two systems communicating through an RS-232 link (external power supply necessary)
<i>external power supply</i>	5V or 12V mains power supply adapter—necessary if the host system does not provide enough electrical power to drive the ScanPlus
<i>interface number</i>	automatically configures your ScanPlus by setting interface-specific parameters—in particular data transmission parameters—to suit your operating environment
<i>keyboard wedge</i>	ScanPlus connected between a keyboard and the host system—data from the ScanPlus is transmitted in keyboard emulation mode to provide instant software compatibility (an external power supply may be necessary)
<i>operating parameters</i>	parameters that affect the way the different ScanPlus models operate—general operating parameters include pushbutton activation, beep and indicator LED settings, operating mode settings, etc.
<i>single-output RS-232 CMM</i>	CMM for RS-232 configuration with external power supply
<i>symbology</i>	bar code type or "family"—Code 39, UPC and EAN are examples of common symbologies

# IBM 46xx cash registers

---

## Connection

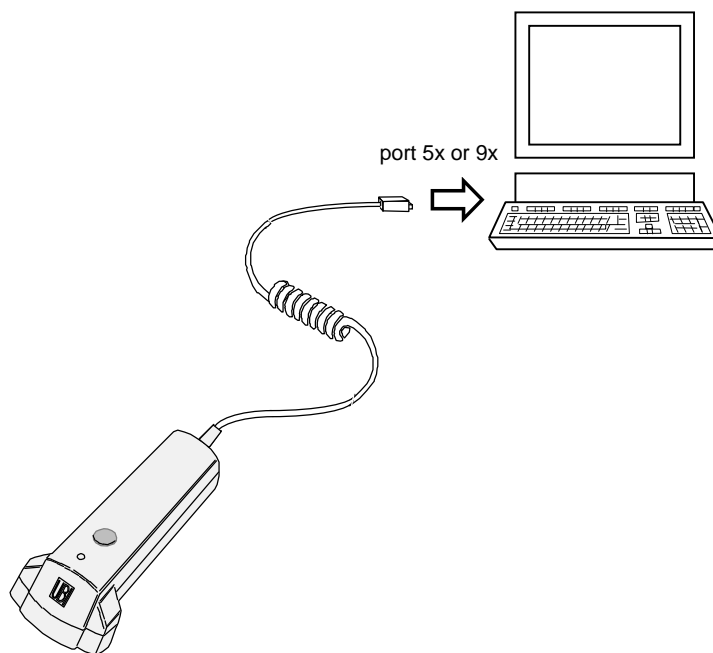

## IBM 46xx cash registers

### Predefined interface numbers

If your interface number is not among the predefined interface numbers, you must compose the number yourself (→ *Compose interface number*).

N° 110 IBM 46xx cash registers—Port 9x



N° 111 IBM 46xx cash registers—Port 5x



## IBM 46xx cash registers

### Predefined data transmission settings

#### Predefined settings for IBM 46xx cash registers - Interface N° 110 / N° 111

The main predefined parameter settings for IBM 46xx cash registers depend on cash register protocols and can not be modified.

### Transmission delay

→ *Inter-message delay*

## Installation procedure

# Installation procedure

---

The *ScanPlus Installation Guide* tells you step by step how to install and set up your ScanPlus to operate successfully in most working situations.

### General installation / configuration procedure

1. Check you have everything you need (→ *Product checklist*).
2. Switch off the host system and connect up your ScanPlus (→ *Connection* for your interface).
3. Switch on the host system.
4. Scan the interface number for your system (→ *Predefined interface numbers* for your interface or *Compose interface number*).
5. Customize the data transmission settings for your interface if required (→ *Data transmission parameters* for your interface).
6. Select the symbologies you need and customize the symbology parameter settings if required (→ *Symbologies*).
7. Customize the ScanPlus operating settings if required (→ *Parameter list / data strings* and individual operating parameter entries).

## Inter-character delay

---

The maximum rate at which data can be transmitted by the ScanPlus is affected by the response of the system. By the insertion of an inter-character delay, the ScanPlus can avoid dropping characters if it is transmitting decoded data too rapidly.

**This feature can only be used with keyboard wedge and RS-232 interfaces and OCIA cash registers.**

### Predefined delay values



### Compose inter-character delay

Example To make your ScanPlus insert an 80 ms delay between characters:

1. Scan Compose Inter-Character Delay on the next page.
2. Scan 8 then 0.
3. Scan End Selection.

## Inter-character delay

Compose Inter-Character Delay (maximum = 999 ms)



End Selection



## Inter-message delay

---

The maximum rate at which data can be transmitted by the ScanPlus is affected by the response of the system. By the insertion of an inter-message delay, the ScanPlus can avoid dropping characters if it is transmitting decoded data too rapidly.

This feature can be used with all interfaces.

### Predefined delay values

No Delay (\*)



10 ms



30 ms



50 ms



80 ms



100 ms



### Compose inter-message delay

**Example** To make your ScanPlus insert a 200 ms delay between messages:

1. Scan Compose Inter- Message Delay on the next page.
2. Scan 2 0 then 0.
3. Scan End Selection.

## Inter-message delay

Compose Inter-Message Delay (maximum = 999 ms)

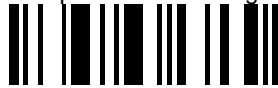

End Selection



# Interfaces

---

## Interface types

If you reset your ScanPlus to its factory default settings (→ *Reset all configuration parameters*), no interface type is selected (null interface). In this case, you will have to re-enter the appropriate interface number for your system (→ *Compose interface number*).

- *IBM 46xx cash registers*
- *Laser emulation*
- *Keyboard wedge*
- *OCIA cash registers*
- *RS-232*
- *Wand emulation*

## Identifying the interface

The Part Number (P/N) indicates the hardware interface setup for your ScanPlus model.  
 The number of green indicator LED flashes at power-up indicates the interface driver selected for your ScanPlus. If you have an energy saver pushbutton model and the pushbutton is activated, you will have to press the pushbutton to see the power-up flashes.

<b>P/N identification</b>	<b>selected interface type</b>	<b>green LED indication</b>
factory default setting (all models)	null interface	continuous LED
x - x x x x x 0 - x x - x x	laser emulation	no LED
x - x x x x x 1 - x x - x x	wand emulation	1 flash
x - x x x x x 2 - x x - x x	RS-232 C	2 flashes
x - x x x x x 3 - x x - x x	IBM 46xx cash registers	3 flashes
x - x x x x x 4 - x x - x x	RS-232 TTL	4 flashes
x - x x x x x 5 - x x - x x	OCIA cash registers	5 flashes
x - x x x x x 7 - x x - x x	keyboard wedge	7 flashes

## Keyboard wedge

# Keyboard wedge

---

### Connection

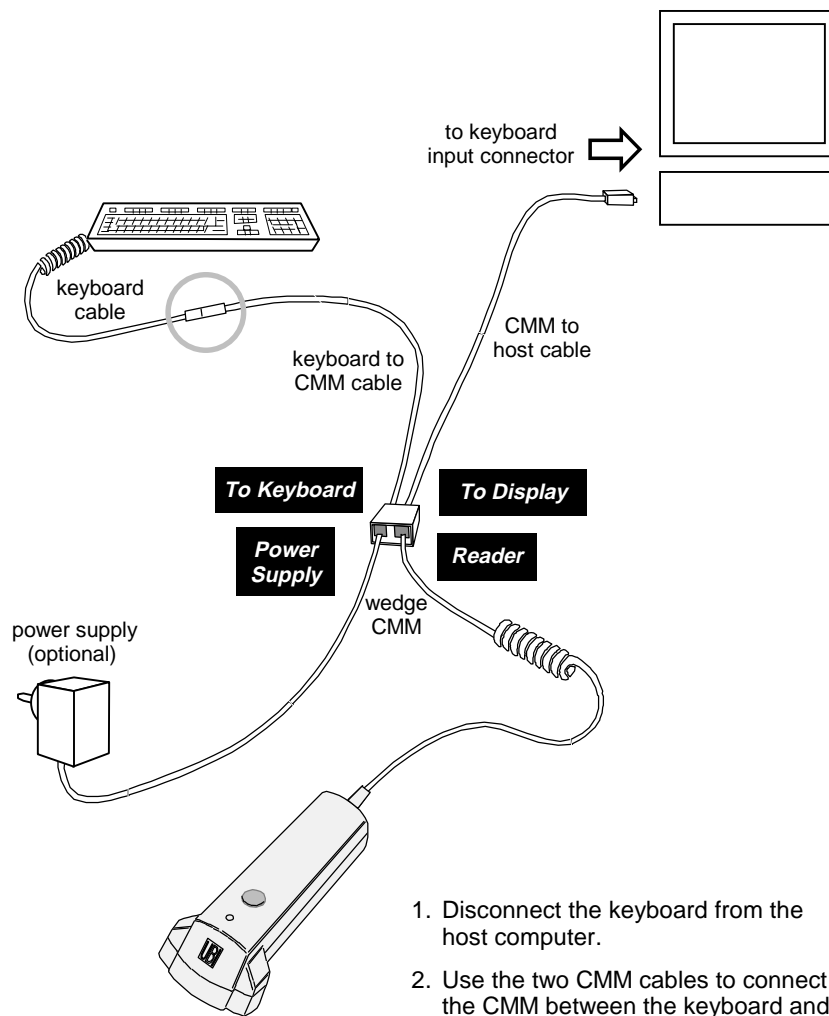

1. Disconnect the keyboard from the host computer.
2. Use the two CMM cables to connect the CMM between the keyboard and the host.

## Keyboard wedge

### Predefined interface numbers

If your interface number is not among the predefined interface numbers, you must compose the number yourself (→ *Compose interface number*).

---

#### IBM PC AT and compatibles



## Keyboard wedge

---

### IBM 31xx, 32xx, 34xx



## Keyboard wedge

---

### DEC VT 220, 320, 420

N° 410 QWERTY - PC type

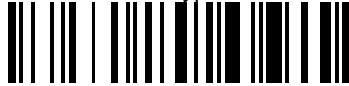

N° 411 AZERTY - PC type



N° 414 QWERTZ - PC type



N° 415 QWERTY - PC type - Swedish /  
Finnish



---

### DEC VT/PC 510

N° 271 AZERTY - PC type



N° 275 QWERTY - PC type - Swedish /  
Finnish

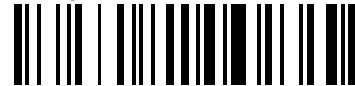

N° 2717 AZERTY - VT type - French



N° 2718 QWERTY - VT type - Swedish /  
Finnish



N° 2720 QWERTZ - PC type - Swiss / French



## Keyboard wedge

---

### Apple / Macintosh



---

### Hewlett Packard 700/92



---

### Wyse 60, 65, 99GT, 120



## Keyboard wedge

### Predefined data transmission settings

#### Predefined settings for keyboard wedge - Interface N° 200

end-of-transmission keyboard character status	-	lower case
end-of-message control code	-	enter
inter-character delay	-	none
inter-message delay	-	none

In this section, the predefined parameter settings for standard keyboard wedge configurations are indicated by an asterisk (\*).

## Keyboard wedge

### Preamble / postamble

The ScanPlus can send preambles and postambles—control codes before and after each message—to emulate command keys on the keyboard and allow automatic data entry:

*<preamble>* *<barcode data>* *<postamble>*

Maximum number of characters in each preamble and postamble:

ScanPlus SP: maximum = 5 characters

ScanPlus ER / XP / PDF: maximum = 10 characters.

Preambles can contain customizable barcode type code marks ( → *Code mark*).

### No preamble / postamble



### Compose preamble / postamble

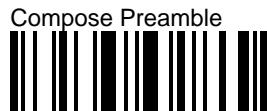

- Example** To enter the STX character (ASCII character 02) as a preamble:
1. Scan Compose Preamble.
  2. Scan one or more character codes you want to include in the preamble—in our example we would scan the ASCII STX character code ( → *ASCII character codes* and *Keyboard wedge—Additional preamble / postamble characters*).
  3. Scan End Selection to finish.

## Keyboard wedge

### Predefined postamble codes



## Keyboard wedge

### Interpreting and transmitting special keyboard keys

→ *Emulating special keyboard keys—Keyboard wedge*

### End-of-transmission keyboard character status

The ScanPlus transmission format is different according to the symbologies used (→ *Symbologies - Character formats and ScanPlus transmission format*).

By default, the ScanPlus sets the keyboard to lower case at the end of transmission.

Lower Case (\*)



Upper Case

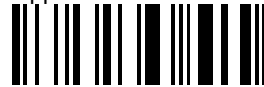

### Transmission delay

→ *Inter-character delay*

→ *Inter-message delay*

Keyboard wedge—Additional preamble / postamble characters

## Keyboard wedge—Additional preamble / postamble characters

---



## Keyboard wedge—Additional preamble / postamble characters

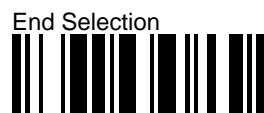
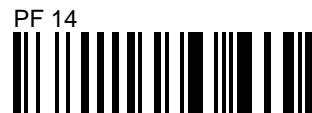

## Keyboard wedge—Additional preamble / postamble characters



## Keyboard wedge—Additional preamble / postamble characters



## Keyboard wedge—Additional preamble / postamble characters

ARROW UP



ARROW DOWN

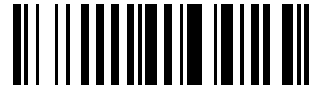

CLEAR



FIELD -



DUP



ESC

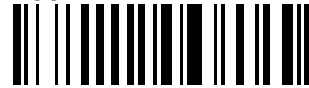

LINE FEED



RESET



---

End Selection



## Laser emulation

# Laser emulation

---

### Connection

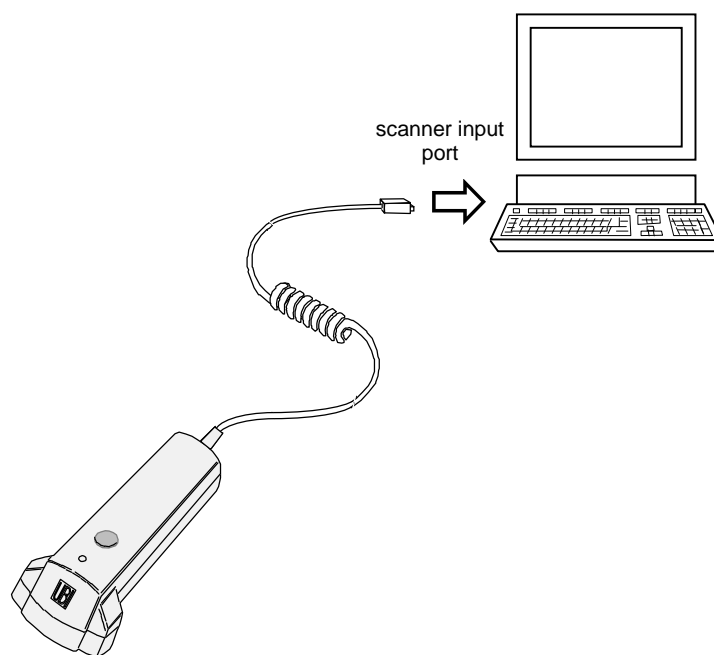

## Laser emulation

### Predefined interface numbers

If your interface number is not among the predefined interface numbers, you must compose the number yourself (→ *Compose interface number*).

N° 132 Laser With Pushbutton



N° 134 Connection to MicroBar LS



## Laser emulation

### Predefined data transmission settings

#### Predefined settings for laser emulation - Interface N° 132

transmitted symbology type	- original code
margin size	- 10 x narrow bar width
logical signal state during transmission	- bar = 1, space = 0, margin = 0
logical signal state outside transmission	- quiet zone = 1

In this section, the predefined parameter settings for Interface N° 132 (standard laser emulation configuration) are indicated by an asterisk (\*).

## Laser emulation

### Transmitted symbology type

In laser emulation, the ScanPlus can transmit data in the original barcode format or converted into Code 39 format, provided that the bar codes contain characters that exist in the Code 39 standard.

Transmission In Original Code (\*)

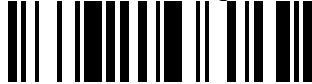

Transmission In Code 39



- Example To transmit Code 128 bar codes in Code 128 format:
- Scan Transmission In Original Code.
- To transmit Code 128 bar codes in Code 39 format:
- Scan Transmission In Code 39.

### Transmission delay

→ *Inter-message delay*

## Laser emulation

### Margin size

#### Predefined margin size

The size of the default margin is 10 times the size of the narrow bar (50  $\mu$ s).



#### Compose margin size



- Example** To set a margin size of 20 x the narrow bar width:
1. Scan Compose Margin Size.
  2. Scan the desired value in narrow-bar increments—in our example we would scan 2 0 (→ *Number codes* or inside back cover of this manual).
  3. Scan End Selection to finish.



# Laser emulation

## Examples of signal state combinations

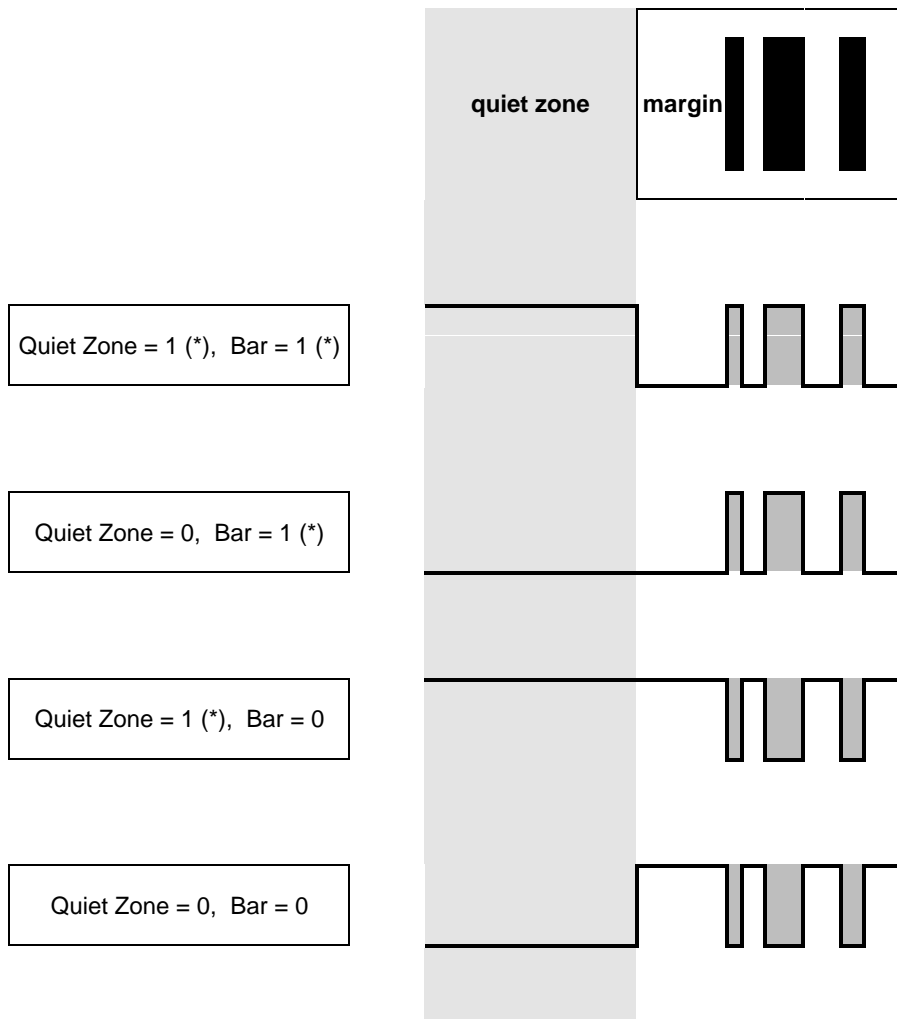

# Number codes

---

Use these number codes to enter custom numerical values required by certain configuration codes. The same number codes are provided on the inside back cover of this manual.



---

End Selection



OCIA cash registers

## OCIA cash registers

---

### Connection

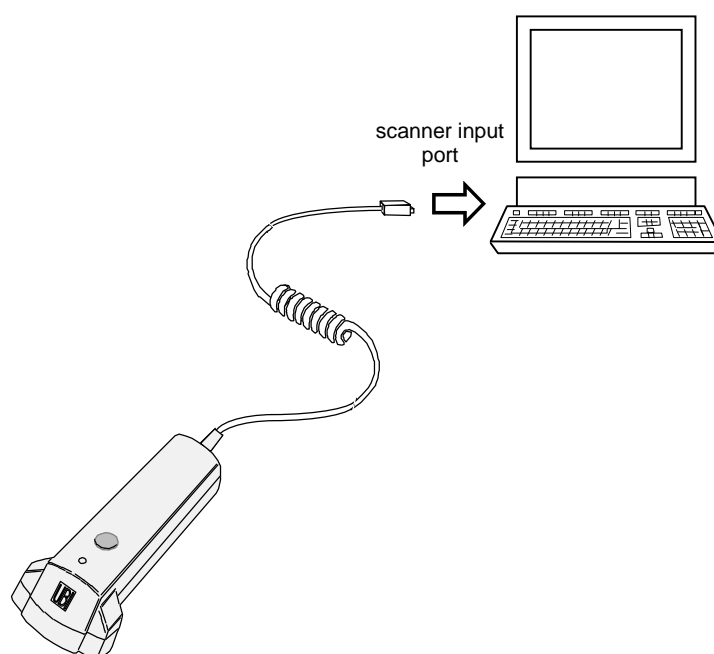

## OCIA cash registers

### Predefined interface numbers

If your interface number is not among the predefined interface numbers, you must compose the number yourself (→ *Compose interface number*).

N° 120 OCIA TEC cash registers  
First Type

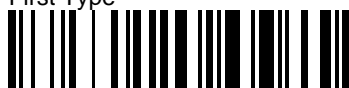

N° 121 OCIA TEC cash registers  
Second Type



N° 122 OCIA NCR cash registers



## OCIA cash registers

### Predefined data transmission settings

#### Predefined settings for OCIA cash registers - Interface N° 120 / N° 121 / N° 122

The main predefined parameter settings for OCIA cash registers depend on cash register protocols and can not be modified.

inter-character delay - none

inter-message delay - none

### Transmission delay

→ *Inter-character delay*

→ *Inter-message delay*

## Parameter list / data strings

---

### Interface numbers

	compose interface number	\41\4A\60
--	--------------------------	-----------

### Keyboard wedge—predefined interface numbers

IBM PC AT and compatibles	N° 200	QWERTY - English	\41\4A\03\08\60
	N° 201	AZERTY - French	\41\4A\03\09\60
	N° 204	QWERTZ - German	\41\4A\03\0C\60
	N° 205	QWERTY - Swedish / Finnish	\41\4A\03\0D\60
	N° 206	QWERTY - Italian	\41\4A\03\0E\60
	N° 207	QWERTY - Norwegian	\41\4A\03\0F\60
	N° 208	QWERTY - Danish	\41\4A\03\10\60
	N° 209	QWERTY - Spanish	\41\4A\03\11\60
	N° 2020	QWERTZ - Swiss / French	\41\4A\1F\24\60
	IBM 31xx, 32xx, 34xx	N° 230	QWERTY - English
N° 231		AZERTY - French	\41\4A\03\27\60
N° 232		AZERTY - international	\41\4A\03\28\60
N° 233		AZERTY - caps QWERTY	\41\4A\03\29\60
N° 234		QWERTZ - German	\41\4A\03\2A\60
N° 2310		QWERTY - data entry	\41\4A\24\06\60
N° 2313		AZERTY - data entry	\41\4A\24\09\60
N° 2314		QWERTZ - numeric keypad	\41\4A\24\0A\60
DEC VT 220, 320, 420	N° 410	QWERTY - PC type	\41\4A\06\1A\60
	N° 411	AZERTY - PC type	\41\4A\06\1B\60
	N° 414	QWERTZ - PC type	\41\4A\06\1E\60
	N° 415	QWERTY - PC type - Swedish / Finnish	\41\4A\06\1F\60

## Parameter list / data strings

DEC VT/PC 510	N° 271	AZERTY - PC type	\41\4A\04\0F\60
	N° 275	QWERTY - PC type - Swedish / Finnish	\41\4A\04\13\60
	N° 2717	AZERTY - VT type - French	\41\4A\2A\1D\60
	N° 2718	QWERTY - VT type - Swedish / Finnish	\41\4A\2A\1E\60
	N° 2720	QWERTZ - PC type - Swiss / French	\41\4A\2A\20\60
Apple / Macintosh	N° 220	QWERTY - English	\41\4A\03\1C\60
	N° 221	AZERTY - French	\41\4A\03\1D\60
	N° 224	QWERTZ - German	\41\4A\03\20\60
Hewlett Packard 700/92	N° 260	QWERTY - English	\41\4A\04\04\60
	N° 261	AZERTY - French	\41\4A\04\05\60
	N° 264	QWERTZ - German	\41\4A\04\08\60
Wyse 60, 65, 99GT, 120	N° 300	QWERTY - 102 keys PC/AT fast	\41\4A\04\2C\60
	N° 301	AZERTY - 102 keys PC/AT fast	\41\4A\04\2D\60
	N° 304	QWERTZ - 102 keys PC/AT fast	\41\4A\04\30\60

### RS-232—predefined interface numbers

	N° 100	standard RS-232 C (9600, 7, E, 2)	\41\4A\01\24\60
	N° 101	RS-232 TTL level	\41\4A\01\25\60
	N° 102	RS-232 PC Term	\41\4A\01\26\60
	N° 103	RS-232 compatible ScanPlus CL slave mode	\41\4A\01\27\60
	N° 105	RS-232 slave mode	\41\4A\01\29\60

### Laser emulation—predefined interface numbers

	N° 132	laser with pushbutton	\41\4A\02\04\60
--	--------	-----------------------	-----------------

## Parameter list / data strings

	N° 134	connection to MicroBar LS	\41\4A\02\06\60
<b>Wand emulation—predefined interface numbers</b>			
	N° 130	digital wand emulation	\41\4A\02\02\60
	N° 131	analog wand emulation	\41\4A\02\03\60
<b>IBM 46xx cash registers—predefined interface numbers</b>			
	N° 110	IBM 46xx cash registers— Port 9x	\41\4A\01\2E\60
	N° 111	IBM 46xx cash registers— Port 5x	\41\4A\01\2F\60
<b>OCIA cash registers—predefined interface numbers</b>			
	N° 120	OCIA TEC cash registers First Type	\41\4A\01\38\60
	N° 121	OCIA TEC cash registers Second Type	\41\4A\01\39\60
	N° 122	OCIA NCR cash registers	\41\4A\01\3A\60

## Parameter list / data strings

### Data transmission parameters

#### Keyboard wedge—data transmission parameters

	preamble	no preamble	\45\53\3E\00\60	
		compose	\45\53\60	
	postamble	no postamble	\45\54\3E\00\60	
		Enter (*)	\45\54\04\02\01\60	
		Carriage Return	\45\54\04\02\02\60	
		Tab	\45\54\04\02\08\60	
		Field Advance	\45\54\04\02\04\60	
		Field Exit	\45\54\04\02\05\60	
		Down Arrow	\45\54\04\02\0F\60	
		compose	\45\54\60	
	special keys interpretation (Code 39)	not active (*)		\42\57\60
		always active		\42\58\60
only active if separate 2-character label or if preceded by a hyphen (-)		\42\59\60		
only active if separate 2-character label		\42\5A\60		
special keys transmission	control characters on (*)		\47\4D\60	
	control characters off		\47\4E\60	
	Alt mode off (*)		\41\47\60	
	Alt mode on		\41\46\60	
end-of-transmission keyboard character status	lower case (*)		\41\44\60	
	upper case		\41\45\60	
inter-character delay	see below			
inter-message delay	see below			

#### RS-232—data transmission parameters

baud rate	9600 (*)	\41\07\60
-----------	----------	-----------

## Parameter list / data strings

	75	\41\00\60
	150	\41\01\60
	300	\41\02\60
	600	\41\03\60
	1200	\41\04\60
	2400	\41\05\60
	4800	\41\06\60
	19200	\41\08\60
	38400	\41\09\60
data bits	7 (*)	\42\60
	8	\43\60
parity	even (*)	\46\01\60
	odd	\46\02\60
	none	\46\00\60
stop bits	2 (*)	\45\60
	1	\44\60
ENQ (Hex 05)	not used (*)	\47\3E\00\60
	ENQ (HEX 05)	\47\3E\05\60
	compose	\47\60
ACK (Hex 06)	not used (*)	\48\3E\00\60
	ACK (HEX 06)	\48\3E\06\60
	compose	\48\60
NAK (Hex 15)	not used (*)	\49\3E\00\60
	NAK (HEX 15)	\49\3E\15\60
	compose	\49\60
XON/XOFF software protocol	not active (*)	\4B\60
	active	\4A\60
CTS/RTS hardware protocol	not active (*)	\4D\60
	active	\4C\60

## Parameter list / data strings

LRC (longitudinal redundancy check)	not active (*)	\4F\60
	active	\4E\60
time-out (hardware and software)	1000 ms (*)	\51\0F\28\60
	unlimited	\51\00\60
	compose (1 to 2500 ms)	\51\60
preamble	no preamble	\45\53\3E\00\60
	compose	\45\53\60
postamble	no postamble	\45\54\3E\00\60
	Carriage Return + Line Feed (*)	\45\54\3E\0D\3E\0A\60
	Carriage Return	\45\54\3E\0D\60
	Line Feed	\45\54\3E\0A\60
	compose	\45\54\60
inter-character delay	see below	
inter-message delay	see below	

### Laser emulation—data transmission parameters

transmitted symbology type	transmission in original code (*)	\5E\00\60
	transmission in Code 39	\5E\01\60
inter-message delay	see below	
margin size	10 x narrow bar width (*)	\5A\0A\60
	compose margin size	\5A\60
logical signal state during transmission	bar = 1, space = 0, margin = 0 (*)	\54\60
	bar = 0, space = 1, margin = 1	\55\60
logical signal state outside transmission	quiet zone = 1 (*)	\57\60
	quiet zone = 0	\56\60

### Wand emulation—data transmission parameters

transmitted symbology type	transmission in original code (*)	\5E\00\60
----------------------------	-----------------------------------	-----------

## Parameter list / data strings

	transmission in Code 39	\5E\01\60
inter-message delay	see below	
margin size	10 x narrow bar width (*)	\5A\0A\60
	compose	\5A\60
logical signal state during transmission	bar = 1, space = 0, margin = 0 (*)	\54\60
	bar = 0, space = 1, margin = 1	\55\60
logical signal state outside transmission	quiet zone = 0 (*)	\56\60
	quiet zone = 1	\57\60
pulse duration	0.88 ms (37.5 cm/s) (*)	\58\01\18\60
	0.19 ms (175 cm/s)	\58\13\60
	0.26 ms (125 cm/s)	\58\1A\60
	0.44 ms (75 cm/s)	\58\2C\60
	0.66 ms (50 cm/s)	\58\01\02\60
	1.32 ms (25 cm/s)	\58\02\04\60
	2.64 ms (12.5 cm/s)	\58\04\08\60
	6.60 ms (5 cm/s)	\58\0A\14\60

### IBM 46xx cash registers—data transmission parameters

inter-message delay	see below	
---------------------	-----------	--

### OCIA cash registers—data transmission parameters

inter-character delay	see below	
inter-message delay	see below	

### Inter-character delay—keyboard wedge, RS-232, OCIA

inter-character delay	none (*)	\52\00\60
	10 ms	\52\0A\60
	20 ms	\52\14\60
	30 ms	\52\1E\60
	40 ms	\52\28\60

## Parameter list / data strings

	50 ms	\52\32\60
	compose (1 to 999 ms)	\52\60

### Inter-message delay—all interfaces

inter-message delay	none (*)	\53\00\60
	10 ms	\53\0A\60
	30 ms	\53\1E\60
	50 ms	\53\32\60
	80 ms	\53\01\10\60
	100 ms	\53\01\24\60
	compose (1 to 999 ms)	\53\60

### Code mark—keyboard wedge, RS-232

activation	code mark not transmitted (*)	\45\56\60
	code mark transmitted	\45\55\60
Default code marks:	Symbology:	Compose code mark:
*	Codablock A	\45\59\14\60
*	Codablock F	\45\59\15\60
D	Codabar	\45\59\04\60
*	Code 39	\45\59\01\60
D	Code 93	\45\59\0D\60
D	Code 128 / EAN 128	\45\59\0B\60
I	Interleaved 2 of 5	\45\59\02\60
D	Matrix 2 of 5	\45\59\0E\60
D	Standard 2 of 5	\45\59\03\60
*	PDF417	\45\59\13\60
D	MSI Code	\45\59\0A\60
D	Plessey Code	\45\59\0C\60
F	UPC-A	\45\59\08\60
E	UPC-E	\45\59\09\60

## Parameter list / data strings

FF	EAN-8	\45\59\07\60
F	EAN-13	\45\59\06\60

### AIM symbology identifiers—keyboard wedge, RS-232

activation	AIM not transmitted (*)	\47\59\60
	AIM transmitted	\47\58\60
Symbology:	AIM symbology identifiers:	
Codablock A	] O 6	
Codablock F	] O 4	
Codabar	] F 0 2 4	
Code 39	] A 0 1 2 4	
Code 93	] G 0	
Code 128 / EAN 128	] C 0 1	
Interleaved 2 of 5	] I 0 1 2	
Matrix 2 of 5	] X 0	
Standard 2 of 5	] S 0 1 2	
PDF417	] L 0	
MSI Code	] M 0 1	
Plessey Code	] P 0	
UPC/EAN, "standard" lengths (8, 13, 15 (add-on 2), 18 (add- on 5) characters)	] E 0 3 4	
UPC/EAN, other lengths (no check digit, . . .)	] X 0	

## Parameter list / data strings

### Symbology parameters

	disable all symbologies	\41\4B\60
--	-------------------------	-----------

#### Codabar

activation	not active (*)	\41\53\60
	active	\41\52\60
start/stop	not transmitted (*)	\43\4D\60
	a, b, c, d	\43\4E\60
	A, B, C, D	\43\4F\60
	a, b, c, d/t, n, *, e	\43\50\60
	DC1, DC2, DC3, DC4	\43\51\60
CLSI library system	not active (*)	\43\53\60
	active	\43\52\60
check digit (AIM recommendation)	not used (*)	\46\56\60
	checked and transmitted	\46\54\60
	checked but not transmitted	\46\55\60
barcode length (number of characters)	minimum length = 6 (*)	\43\55\06\60
	any length	\43\55\00\60
	compose minimum length	\43\55\60
	compose 1 or 2 fixed lengths	\43\54\60

#### Codablock

activation	not active (*)	\47\45\60
	active (only available ScanPlus XP/PDF)	\47\44\60
Codablock type	Codablock F (*)	\47\47\60
	Codablock A	\47\46\60
time-out between reads	active (*)	\47\52\60
	not active	\47\53\60

## Parameter list / data strings

check digit	not transmitted (*)	\47\57\60
	transmitted	\47\56\60
<b>Code 39</b>		
activation	active (*) (ScanPlus SP / ER / XP)	\41\4C\60
	not active (*) (ScanPlus PDF)	\41\4D\60
Code 39 type	standard 43 characters (*)	\42\4A\60
	full ASCII	\42\4B\60
start/stop	not transmitted (*)	\42\4D\60
	transmitted	\42\4C\60
accepted start/stop characters	" * " only (*)	\42\4E\02\60
	" \$ " only	\42\4E\01\60
	" \$ " and " * " accepted	\42\4E\03\60
check digit	not used (*)	\42\4F\60
modulo 43 check digit	checked and transmitted	\42\50\60
	checked but not transmitted	\42\51\60
French CIP check digit	checked and transmitted	\42\52\60
	checked but not transmitted	\42\53\60
Italian CPI check digit	checked and transmitted	\42\54\60
	checked but not transmitted	\42\55\60
barcode length (number of characters)	any length (*)	\42\5C\00\60
	minimum length = 6	\42\5C\06\60
	compose minimum length	\42\5C\60
special keys interpretation	not active (*)	\42\57\60
	always active	\42\58\60
	only active if separate 2-character label or if preceded by a hyphen (-)	\42\59\60
	only active if separate 2-character label	\42\5A\60

## Parameter list / data strings

### Code 93

activation	not active (*)	\41\5F\60
	active	\41\5E\60
barcode length (number of characters)	any length (*)	\45\42\00\60
	minimum length = 6	\45\42\06\60
	compose minimum length	\45\42\60

### Code 128 / EAN 128

activation	not active (*)	\41\5B\60
	active	\41\5A\60
barcode length (number of characters)	any length (*)	\44\55\00\60
	minimum length = 6	\44\55\06\60
	compose minimum length	\44\55\60
FNC1 separator character— EAN-128 norms	GS function character (ASCII 29)	\46\52\60

### Interleaved 2 of 5

activation	not active (*)	\41\4F\60
	active	\41\4E\60
check digit	not used (*)	\43\43\60
check digit mod 10	checked and transmitted	\42\5F\60
	checked but not transmitted	\43\40\60
French CIP HR check digit	checked and transmitted	\43\41\60
	checked but not transmitted	\43\42\60
barcode length (number of characters)	minimum length = 6 (*)	\43\45\06\60
	any length	\43\45\00\60
	compose minimum length	\43\45\60
	compose 1 or 2 fixed lengths	\43\44\60

## Parameter list / data strings

### Matrix 2 of 5

activation	not active (*)	\42\41\60
	active	\42\40\60
barcode length (number of characters)	minimum length = 6 (*)	\46\59\06\60
	any length	\46\59\00\60
	compose minimum length	\46\59\60

### MSI Code

activation	not active (*)	\41\59\60
	active	\41\58\60
check digit mod 10	checked and transmitted (*)	\44\5A\60
	checked but not transmitted	\44\5C\60
check digit double mod 10	checked and transmitted	\44\5B\60
	checked but not transmitted	\44\5D\60
barcode length (number of characters)	minimum length = 6 (*)	\44\5F\06\60
	any length	\44\5F\00\60
	compose minimum length	\44\5F\60

### PDF417

activation	active (*) (only available ScanPlus PDF)	\48\4E\60
	not active	\48\4D\60

### Plessey Code

activation	not active (*)	\41\5D\60
	active	\41\5C\60
check digit	not transmitted (*)	\44\57\60
	transmitted	\44\56\60
barcode length (number of characters)	any length (*)	\44\59\00\60

## Parameter list / data strings

	minimum length = 6	\44\59\06\60
	compose minimum length	\44\59\60

### Standard 2 of 5

activation	not active (*)	\41\51\60
	active	\41\50\60
start/stop bars	Identicon (6 Bars) (*)	\43\47\60
	Computer Identics (4 Bars)	\43\46\60
check digit mod 10	not used (*)	\43\4A\60
	checked and transmitted	\43\48\60
	checked but not transmitted	\43\49\60
barcode length (number of characters)	minimum length = 6 (*)	\43\4C\06\60
	any length	\43\4C\00\60
	compose minimum length	\43\4C\60
	compose 1 or 2 fixed lengths	\43\4B\60

### UPC/EAN code families (UPC-A, UPC-E, EAN-8, EAN-13)

activation	active (*) (ScanPlus SP / ER / XP)	\41\56\60
	not active (*) (ScanPlus PDF)	\41\57\60
UPC/EAN format activation	all active—UPC-A, UPC-E, EAN-8, EAN-13 (*)	\43\5C\60
	UPC-A deactivated	\43\5D\60
	UPC-E deactivated	\43\5E\60
	EAN-8 deactivated	\43\5F\60
	EAN-13 deactivated	\44\40\60
add-on digits	not required but transmitted if read (*)	\44\43\60
	required and transmitted	\44\42\60
add-on 2	not active (*)	\44\41\60
	active	\46\44\60
add-on 5	not active (*)	\46\46\60

## Parameter list / data strings

	active	\46\45\60
UPC-A check digit	transmitted (*)	\44\46\60
	not transmitted	\44\47\60
UPC-E check digit	transmitted (*)	\44\4A\60
	not transmitted	\44\4B\60
EAN-8 check digit	transmitted (*)	\46\49\60
	not transmitted	\46\4A\60
EAN-13 check digit	transmitted (*)	\46\47\60
	not transmitted	\46\48\60
UPC-A number system	transmitted (*)	\44\44\60
	not transmitted	\44\45\60
UPC-E number system	transmitted (*)	\44\48\60
	not transmitted	\44\49\60
re-encoding UPC-A, UPC-E, EAN-8	UPC-A transmitted as EAN-13 (*)	\44\4F\60
	UPC-A transmitted as UPC-A	\44\4E\60
	UPC-E transmitted as UPC-E (*)	\44\4C\60
	UPC-E transmitted as UPC-A	\44\4D\60
	EAN-8 transmitted as EAN 8 (*)	\44\50\60
	EAN-8 transmitted as EAN-13	\44\51\60

## Parameter list / data strings

### ScanPlus operating parameters

	reset factory defaults	\46\42\60
	software / CPU versions	\46\43\60

### Interfaces

	null interface (*) (no interface driver selected—no transmission)	
	keyboard wedge	
	RS-232 C	
	RS-232 TTL	
	laser emulation	
	wand emulation	
	IBM 46xx cash registers	
	OCIA cash registers	

### Symbologies

	Codabar	
	Codablock (only available ScanPlus XP / PDF)	
	Code 39 (*) (ScanPlus SP / ER / XP)	
	Code 93	
	Code 128 / EAN 128	
	Interleaved 2 of 5	
	Matrix 2 of 5	
	MSI Code	
	PDF417 (*) (only available ScanPlus PDF)	
	Plessey Code	
	Standard 2 of 5	

## Parameter list / data strings

	UPC/EAN code families (UPC-A, UPC-E, EAN-8, EAN-13) (*) (ScanPlus SP / ER / XP)	
<b>Pushbutton models</b>		
all pushbutton models	pushbutton not active (*)	\45\5D\00\60
standard pushbutton models	active for read duration (2 s), repeat read duration after good read	\46\5D\45\5D\02\46\4C\60
	active for read duration (2 s), standby after good read	\46\5D\45\5D\02\46\4D\60
	active while pushbutton pressed, standby after good read	\46\5D\46\5A\03\3F\46\4D\60
standard pushbutton models—aiming beam	active for read duration (2 s), repeat read duration after good read	\46\5C\45\5D\02\46\4C\60
	active for read duration (2 s), standby after good read	\46\5C\45\5D\02\46\4D\60
	active while pushbutton pressed, standby after good read	\46\5C\46\5A\03\3F\46\4D\60
energy saver pushbutton models	active for read duration (2 s), repeat read duration after good read	\46\5B\45\5D\02\46\4C\60
	active for read duration (2 s), standby after good read	\46\5B\45\5D\02\46\4D\60
	active while pushbutton pressed, standby after good read	\46\5B\46\5A\03\3F\46\4D\60
pushbutton read duration	compose (default 2 s, maximum = 65 s)	\45\5D\60
<b>Flashing mode</b>		
LED economizer flash	flash after 10 minutes (*)	\47\51\0A\47\42\47\4F\60
	no flash	\47\41\00\47\43\60
	compose time-out before flash (1 to 60 minutes)	\47\51\47\42\47\4F\60
<b>Configuration modes</b>		
configuration authorization modes	enable (*)	\46\50\60

## Parameter list / data strings

	configuration inhibit after 1 mn	\46\51\60
temporary configuration mode	enable	\46\41\00\60
	restore current configuration	\46\41\01\60
	update current configuration	\46\41\02\60
transparent configuration mode	enable	\46\41\03\60
display data string mode	enable	\46\4E\60
RS-232 slave mode	enable	\41\4A\01\29\60

### Beeps / green indicator LED

power-up beeps / power-up LED	on (*)	\45\5B\60
	off	\45\5A\60
good read beeps	1 beep (*)	\45\4A\00\60
	2 beeps	\45\4A\01\60
	no beep	\45\49\00\60
timing of good read beeps	before transmission (*)	\45\52\60
	after transmission	\45\51\60
duration of good read beeps	80 ms (*)	\45\49\01\10\60
	60 ms	\45\49\3C\60
	200 ms	\45\49\04\2C\60
	300 ms	\45\49\03\08\60
	compose beep duration (0 to 999 ms)	\45\49\60
good read LED	on (*)	\45\4F\01\10\60
	off	\45\4F\00\60
2D crackle / LED flicker	crackle on (*)	\48\4A\60
	LED flicker on	\48\4B\60
	crackle off - LED flicker off	\48\4C\60

## Parameter list / data strings

### Data decoding security parameters

predefined security levels	normal security level (*)	\45\4E\00\60
	medium security level	\45\4E\01\60
	high security level	\45\4E\02\60
consecutive same read data validation	single read before transmission (*)	\45\4B\01\60
	compose number of consecutive same reads before transmission (maximum = 10)	\45\4B\60
time-out between identical consecutive codes	300 ms (*)	\45\4C\04\2C\60
	compose (maximum = 2550 ms)	\45\4C\60
time-out between different consecutive codes	no time-out (*)	\45\4D\0A\60
	compose (maximum = 2550 ms)	\45\4D\60

### Scan rate parameters—ScanPlus SP

scan rate	90 scans/s (*)	\46\40\02\08\60
	115 scans/s	\46\40\02\06\60
	140 scans/s	\46\40\02\05\60
	230 scans/s	\46\40\02\03\60
scan rate / decode rate ratio	decode rate = scan rate (*)	\46\40\01\60
	decode rate = scan rate / 2	\46\40\00\60

## Parameter list / data strings

### Data string values

	end selection	\64\60
--	---------------	--------

### Number codes

	0	\10\60
	1	\11\60
	2	\12\60
	3	\13\60
	4	\14\60
	5	\15\60
	6	\16\60
	7	\17\60
	8	\18\60
	9	\19\60

### ASCII character codes

	NUL (00h)	\3E\00\60
	SOH (01h)	\3E\01\60
	STX (02h)	\3E\02\60
	ETX (03h)	\3E\03\60
	EOT (04h)	\3E\04\60
	ENQ (05h)	\3E\05\60
	ACK (06h)	\3E\06\60
	BEL (07h)	\3E\07\60
	BS (08h)	\3E\08\60
	HT or TAB (09h)	\3E\09\60
	LF (0Ah)	\3E\0A\60
	VT (0Bh)	\3E\0B\60
	FF (0Ch)	\3E\0C\60

## Parameter list / data strings

	CR (0Dh)	\3E\0D\60
	SO (0Eh)	\3E\0E\60
	SI (0Fh)	\3E\0F\60
	DLE (10h)	\3E\10\60
	DC1 (11h)	\3E\11\60
	DC2 (12h)	\3E\12\60
	DC3 (13h)	\3E\13\60
	DC4 (14h)	\3E\14\60
	NAK (15h)	\3E\15\60
	SYN (16h)	\3E\16\60
	ETB (17h)	\3E\17\60
	CAN (18h)	\3E\18\60
	EM (19h)	\3E\19\60
	SUB (1Ah)	\3E\1A\60
	ESC (1Bh)	\3E\1B\60
	FS (1Ch)	\3E\1C\60
	GS (1Dh)	\3E\1D\60
	RS (1Eh)	\3E\1E\60
	US (1Fh)	\3E\1F\60
	SP (20h)	\00\60
	! (21h)	\01\60
	" (22h)	\02\60
	# (23h)	\03\60
	\$ (24h)	\04\04\60
	% (25h)	\05\60
	& (26h)	\06\60
	' (27h)	\07\60
	( (28h)	\08\60
	) (29h)	\09\60

## Parameter list / data strings

	* (2Ah)	\0A\60
	+ (2Bh)	\0B\60
	, (2Ch)	\0C\60
	- (2Dh)	\0D\60
	. (2Eh)	\0E\60
	/ (2Fh)	\0F\0F\60
	0 (30h)	\10\60
	1 (31h)	\11\60
	2 (32h)	\12\60
	3 (33h)	\13\60
	4 (34h)	\14\60
	5 (35h)	\15\60
	6 (36h)	\16\60
	7 (37h)	\17\60
	8 (38h)	\18\60
	9 (39h)	\19\60
	: (3Ah)	\1A\60
	; (3Bh)	\1B\60
	< (3Ch)	\1C\60
	= (3Dh)	\1D\60
	> (3Eh)	\1E\60
	? (3Fh)	\1F\60
	@ (40h)	\20\20\60
	A (41h)	\21\60
	B (42h)	\22\60
	C (43h)	\23\60
	D (44h)	\24\60
	E (45h)	\25\60

## Parameter list / data strings

	F (46h)	\26\60
	G (47h)	\27\60
	H (48h)	\28\60
	I (49h)	\29\60
	J (4Ah)	\2A\60
	K (4Bh)	\2B\60
	L (4Ch)	\2C\60
	M (4Dh)	\2D\60
	N (4Eh)	\2E\60
	O (4Fh)	\2F\60
	P (50h)	\30\60
	Q (51h)	\31\60
	R (52h)	\32\60
	S (53h)	\33\60
	T (54h)	\34\60
	U (55h)	\35\60
	V (56h)	\36\60
	W (57h)	\37\60
	X (58h)	\38\60
	Y (59h)	\39\60
	Z (5Ah)	\3A\60
	[ (5Bh)	\3B\60
	\ (5Ch)	\3C\60
	] (5Dh)	\3D\60
	^ (5Eh)	\3E\3E\60
	_ (5Fh)	\3F\60
	' (60h)	\20\20\60
	a (61h)	\20\21\60
	b (62h)	\20\22\60

## Parameter list / data strings

	c (63h)	\20\23\60
	d (64h)	\20\24\60
	e (65h)	\20\25\60
	f (66h)	\20\26\60
	g (67h)	\20\27\60
	h (68h)	\20\28\60
	i (69h)	\20\29\60
	j (6Ah)	\20\2A\60
	k (6Bh)	\20\2B\60
	l (6Ch)	\20\2C\60
	m (6Dh)	\20\2D\60
	n (6Eh)	\20\2E\60
	o (6Fh)	\20\2F\60
	p (70h)	\20\30\60
	q (71h)	\20\31\60
	r (72h)	\20\32\60
	s (73h)	\20\33\60
	t (74h)	\20\34\60
	u (75h)	\20\35\60
	v (76h)	\20\36\60
	w (77h)	\20\37\60
	x (78h)	\20\38\60
	y (79h)	\20\39\60
	z (7Ah)	\20\3A\60
	\{ (7Bh)	\20\3B\60
	(7Ch)	\20\3C\60
	} (7Dh)	\20\3D\60
	~ (7Eh)	\20\3 E\60
	DEL (7Fh)	\20\3F\60

## Parameter list / data strings

### Additional preamble / postamble characters—Keyboard wedge

	PF 1	\04\02\18\60
	PF 2	\04\02\19\60
	PF 3	\04\02\1A\60
	PF 4	\04\02\1B\60
	PF 5	\04\02\1C\60
	PF 6	\04\02\1D\60
	PF 7	\04\02\1E\60
	PF 8	\04\02\1F\60
	PF 9	\04\02\20\60
	PF 10	\04\02\21\60
	PF 11	\04\02\22\60
	PF 12	\04\02\23\60
	PF 13	\04\02\24\60
	PF 14	\04\02\25\60
	PF 15	\04\02\26\60
	PF 16	\04\02\27\60
	PF 17	\04\02\28\60
	PF 18	\04\02\29\60
	PF 19	\04\02\2A\60
	PF 20	\04\02\2B\60
	PF 21	\04\02\2C\60
	PF 22	\04\02\2D\60
	PF 23	\04\02\2E\60
	PF 24	\04\02\2F\60
	DEL	\04\02\00\60
	ENTER	\04\02\01\60
	RETURN	\04\02\02\60
	SEND	\04\02\03\60

## Parameter list / data strings

	FIELD +	\04\02\04\60
	FIELD EXIT	\04\02\05\60
	HOME	\04\02\06\60
	END	\04\02\07\60
	TAB = Ctrl i	\04\02\08\60
	ALT	\04\02\09\60
	BACK TAB	\04\02\0A\60
	BACK SPACE	\04\02\0B\60
	ARROW RIGHT	\04\02\0C\60
	ARROW LEFT	\04\02\0D\60
	ARROW UP	\04\02\0E\60
	ARROW DOWN	\04\02\0F\60
	CLEAR	\04\02\10\60
	FIELD -	\04\02\11\60
	DUP	\04\02\12\60
	ESC	\04\02\13\60
	LINE FEED	\04\02\14\60
	RESET	\04\02\15\60

## Preamble / postamble

---

→ *Keyboard wedge - Preamble / postamble*

→ *RS-232 - Preamble / postamble*

 **Do not try to configure preambles or postambles for IBM 46xx cash registers, laser emulation, OCIA cash registers, wand emulation.**

## Product checklist

# Product checklist

---

- all systems**
- ScanPlus
  - ScanPlus Installation Guide*
  - ScanPlus user's leaflet
- options**
- external power supply
  - keyboard wedge CMM and associated keyboard/system cables
  - single-output or dual-output RS-232 CMM and associated cables if applicable
  - ScanPlus Reference Manual*

## Pushbutton models

---

**By default, the pushbutton on ScanPlus pushbutton models is deactivated.**

To activate the pushbutton, you must select the appropriate pushbutton activation code for your ScanPlus model (→ *Pushbutton models—Activation*).

### Standard pushbutton models

Standard pushbutton models are suitable for standard applications where energy consumption is not a critical parameter.

When the ScanPlus goes into standby after one of the time-out conditions has been satisfied, the reading light and read function are switched off. Full energy is restored when the next reading situation occurs.

Standard pushbutton models consume more energy than energy saver models but they have other advantages:

- faster wake-up time,
- keyboard-host communication ensured after ScanPlus time-out (necessary for wedge applications for example),
- no current peaks during reading.

## Pushbutton models

### Energy saver pushbutton models

Energy saver pushbutton models are specially designed for energy-critical applications—using the ScanPlus with laptop computers for example.

When the ScanPlus goes into standby after one of the time-out conditions has been satisfied, current consumption drops to zero until the next reading situation occurs.

Energy saver pushbutton models consume less energy than standard pushbutton models but they have a slightly longer wake-up delay and are not suitable for all applications.

## Pushbutton models—Activation

---

### Pushbutton deactivation

By default, the pushbutton on ScanPlus pushbutton models is deactivated.



### Pushbutton activation

To activate the pushbutton, you must select a pushbutton operating scenario.

The same three operating scenarios are available for all ScanPlus pushbutton models (standard or energy saver):

- Active For Read Duration (2 s)—Repeat Read Duration After Good Read
- Active For Read Duration (2 s)—Standby After Good Read
- Active While Pushbutton Pressed—Standby After Good Read

The ScanPlus does not flash in standby when the pushbutton is activated.

## Pushbutton models—Activation

### Pushbutton operating scenarios

#### Active For Read Duration (2 s)—Repeat Read Duration After Good Read

This configuration allows you to read a number of bar codes after a single press of the pushbutton.

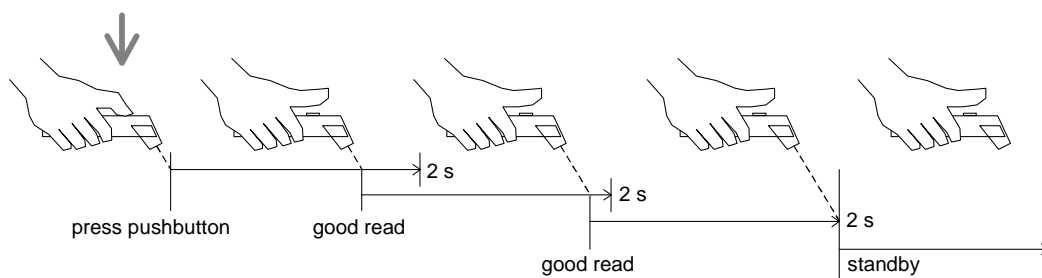

#### Active For Read Duration (2 s)—Standby After Good Read

This configuration is useful to avoid double reading—when bar codes are close together for example.

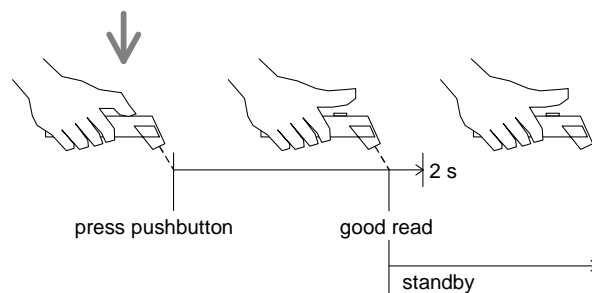

## Pushbutton models—Activation

### Active While Pushbutton Pressed—Standby After Good Read

This configuration is useful for selective reading of single bar codes.

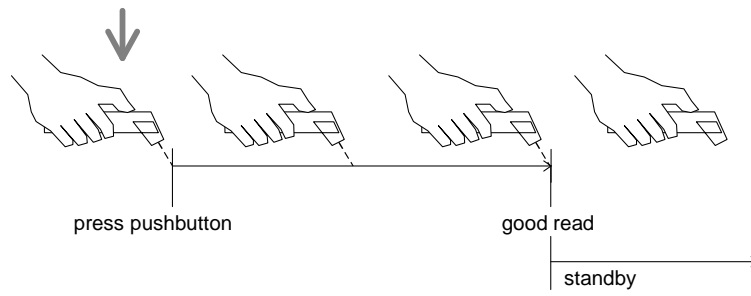

## Pushbutton models—Activation

### Standard pushbutton models

Only supported by ScanPlus models with part numbers 0-xxxxxx-2x-xx.



**Do not use these codes with ScanPlus models that do not have a pushbutton.**

Standard Pushbutton

Active For Read Duration (2 s)—Repeat Read Duration After Good Read



Standard Pushbutton

Active For Read Duration (2 s)—Standby After Good Read



Standard Pushbutton

Active While Pushbutton Pressed—Standby After Good Read



## Pushbutton models—Activation

### Standard pushbutton models—Aiming beam

Only supported by ScanPlus ER / XP / PDF models with part numbers 0-xxxxxx-2x-xx.

ScanPlus ER / XP / PDF standard pushbutton models can be configured to produce an aiming beam when in standby mode. The aiming beam is a red light used to position the ScanPlus correctly over the bar codes before reading is activated.



**Do not use these codes with ScanPlus models that do not have a pushbutton.**

Standard Pushbutton—Aiming Beam  
Active For Read Duration (2 s)—Repeat Read Duration After Good Read



Standard Pushbutton—Aiming Beam  
Active For Read Duration (2 s)—Standby After Good Read



Standard Pushbutton—Aiming Beam  
Active While Pushbutton Pressed—Standby After Good Read



## Pushbutton models—Activation

### Energy saver pushbutton models

Only supported by ScanPlus models with part numbers 0-xxxxxx-1x-xx.

Activating energy saver pushbutton models deactivates the power-up beeps and power-up LED—they can not be activated in Energy Saver mode.



**Do not use these codes with ScanPlus models that do not have a pushbutton.**

Energy Saver

Active For Read Duration (2 s)—Repeat Read Duration After Good Read



Energy Saver

Active For Read Duration (2 s)—Standby After Good Read



Energy Saver

Active While Pushbutton Pressed—Standby After Good Read



## Pushbutton models—Activation

### Compose read duration

By default, the ScanPlus remains active (reading) for 2 seconds when the pushbutton is pressed.

**Activating the pushbutton (standard or energy saver pushbutton models) resets the default read duration value (2 s). If you want to modify the read duration, you must select Compose Read Duration after you have activated the pushbutton.**

Compose Read Duration  
(default 2 s, maximum = 65 s)



- Example** To make your ScanPlus remain active and read for 20 seconds after you have pressed the pushbutton:
1. Scan Compose Read Duration.
  2. Scan 2 0 then scan End Selection (→ *Number codes* or inside back cover of this manual).

## Reset all configuration parameters

# Reset all configuration parameters

---

### Reset factory defaults

Reset Factory Defaults resets all the ScanPlus parameters to their factory default settings:

- null interface (no interface driver selected—no transmission),
- default symbologies,
- default symbology settings,
- default ScanPlus operating settings (pushbutton deactivated, LED / beep settings, etc.).

→ *Parameter list / data strings* provides the full list of parameters and default settings.

 **If you scan Reset Factory Defaults, you will have to re-enter the appropriate interface number for your system and any custom settings if applicable. It is often easier to reset individual parameters.**

Reset Factory Defaults



### General reset procedure

1. Make a list of your custom ScanPlus parameter settings if applicable.
2. Scan Reset Factory Defaults.
3. Scan the interface number for your system (→ *Predefined interface numbers* for your interface or *Compose interface number*).
4. Customize the data transmission settings for your interface if required (→ *Data transmission parameters* for your interface).
5. Select the symbologies you need and customize the symbology parameter settings if required (→ *Symbologies*).
6. Customize the ScanPlus operating settings if required (→ *Parameter list / data strings, Pushbutton models—Activation, etc.*).

# RS-232

---

## Direct connection

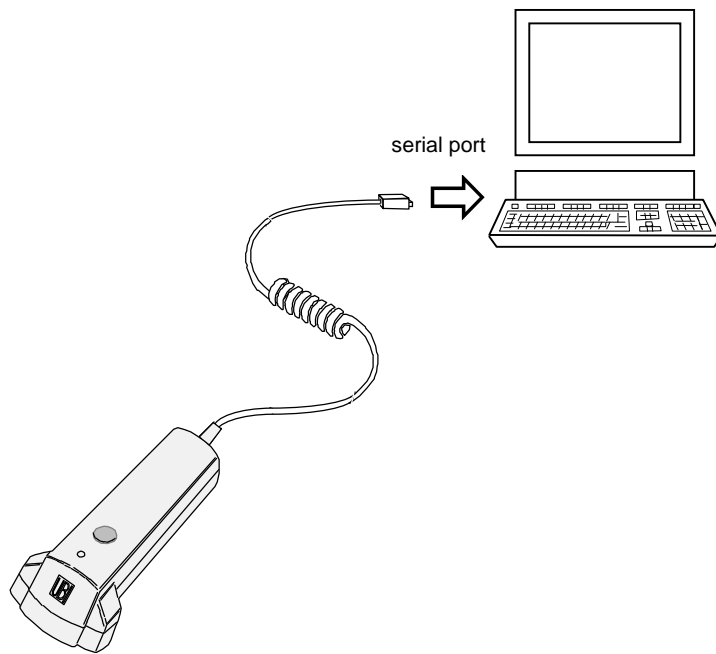

## RS-232

### Single-output connection—External power supply

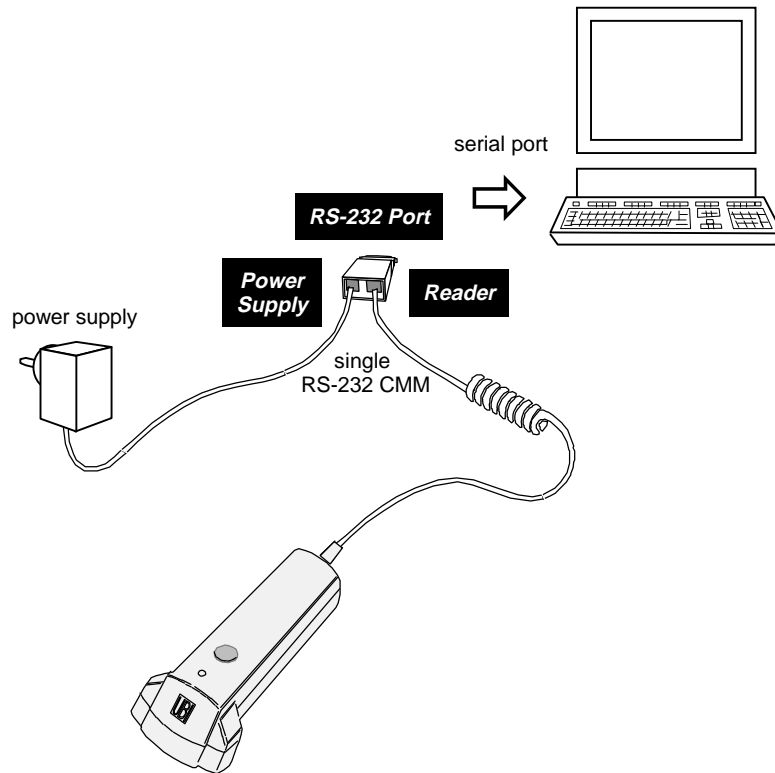

→ Single-output CMM pin assignments below

**Single-output CMM pin assignments**

<b>Standard DB-25S "DTE" female (P/N 704300)</b>		<b>Standard DB-25S "DTE" male (P/N 704310)</b>	
1	Frame Ground	1	Frame Ground
2	Transmit Data	2	Transmit Data
3	Receive Data	3	Receive Data
4	Request to Send	4	Request to Send
5	Clear to Send	5	Clear to Send
6	NC	6	NC
7	Signal Ground	7	Signal Ground
8	NC	8	NC
12	+5 Volts	12	+5 Volts
20	NC	20	NC

  

<b>Standard DB-25S "DCE" female (P/N 704320)</b>		<b>Standard AT 9-pin serial "DCE" female (P/N 704340)</b>	
1	Frame Ground	1	NC
2	Receive Data	2	Transmit Data
3	Transmit Data	3	Receive Data
4	Clear to Send	4	NC
5	Request to Send	5	Signal Ground
6	NC	6	NC
7	Signal Ground	7	Clear to Send
8	NC	8	Request to Send
12	+5 Volts	9	NC
20	NC		

pins 6, 8, and 20 on 25-pin connectors are shorted
--

## RS-232

### Dual-output connection

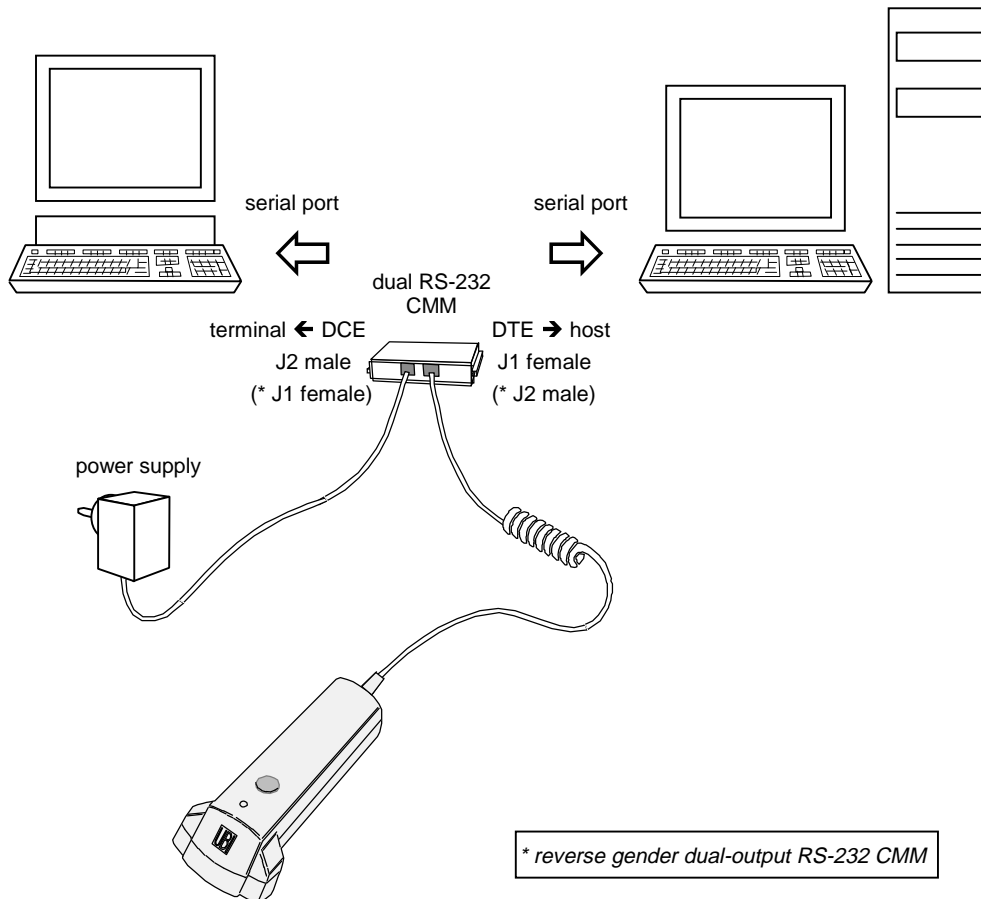

By default, dual-output RS-232 CMMs for the ScanPlus are configured for data transmission on the DTE connector (to host) only.

By modifying internal jumper settings, the dual-output RS-232 CMM can be set to transmit data on the DCE connector (to terminal) only or on both DTE and DCE ( $\rightarrow$  *Dual-output CMM—Jumper settings* below).

**Dual-output CMM—Jumper settings**

To change the jumper settings, remove the four attachment screws and remove the cover of the CMM.

Jumper settings are identical for standard and reverse gender dual-output RS-232 CMMs.

**Make sure the TO HOST and TO TERMINAL labels are correctly positioned when you reassemble the CMM.**

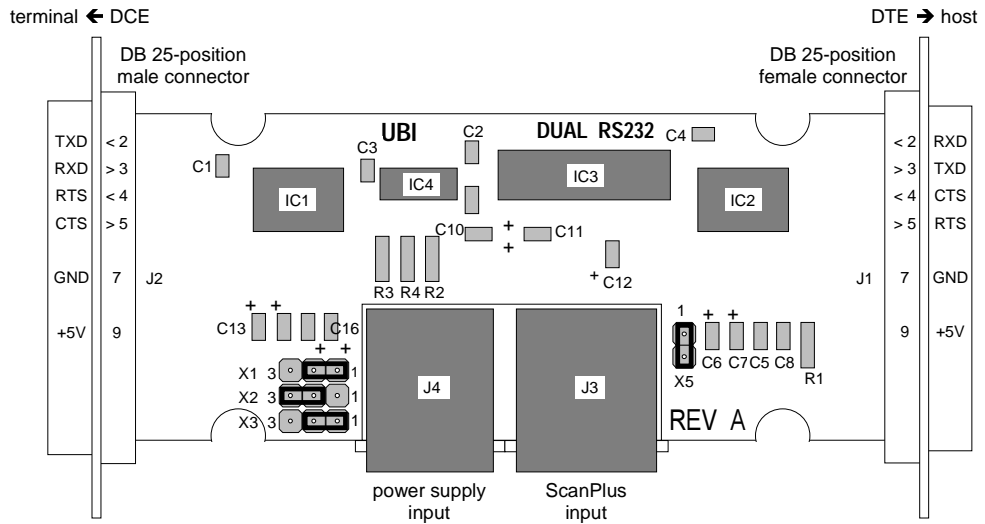

**Data transmission**

transmit to host only (default)

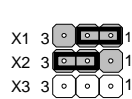

transmit to terminal only

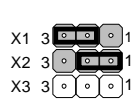

transmit to host and terminal

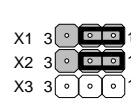

**ScanPlus-host RTS/CTS handshaking**

RTS/CTS handshaking on (default)

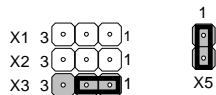

RTS/CTS handshaking off

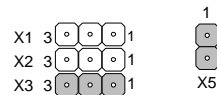

## RS-232

### Predefined interface numbers

If your interface number is not among the predefined interface numbers, you must compose the number yourself (→ *Compose interface number*).

N° 100 Standard RS-232 C (9600, 7, E, 2)



N° 101 RS-232 TTL Level



N° 102 RS-232 PC Term

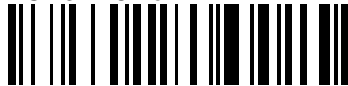

N° 103 RS-232 Compatible ScanPlus CL  
Slave Mode



N° 105 RS-232 Slave Mode

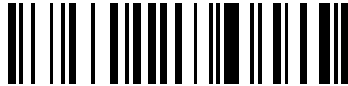

→ *RS-232—Slave mode*

## Predefined data transmission settings

### Predefined settings for RS-232 - Interface N° 100

baud rate	-	9600
data bits	-	7
parity	-	even
stop bits	-	2
ENQ (Hex 05)	-	not used
ACK (Hex 06)	-	not used
NAK (Hex 15)	-	not used
XON/XOFF (software)	-	inactive
CTS/RTS (hardware)	-	inactive
LRC (longitudinal redundancy check)	-	inactive
time-out (hardware and software)	-	1000 ms
end-of-message control code	-	carriage return + line feed
inter-character delay	-	none
inter-message delay	-	none

In this section, the predefined parameter settings for interface N° 100 (Standard RS-232) are indicated by an asterisk (\*).

# RS-232

## Baud Rate



**Data bits**



**Parity**



**Stop bits**



## RS-232

### ENQ / ACK / NAK software protocol

(1) To use a different character for ENQ / ACK / NAK:

1. Scan Compose Other Character.
2. Scan the desired character code (→ *ASCII character codes*).
3. Scan End Selection.

#### ENQ enquiry character

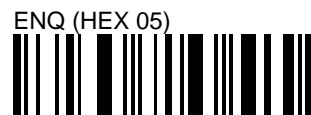

#### ACK acknowledge character

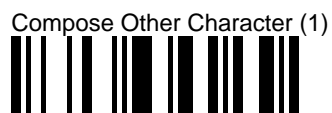

**NAK negative acknowledge character**

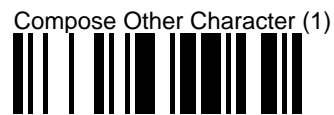

**Typical ENQ / ACK / NAK scenarios**

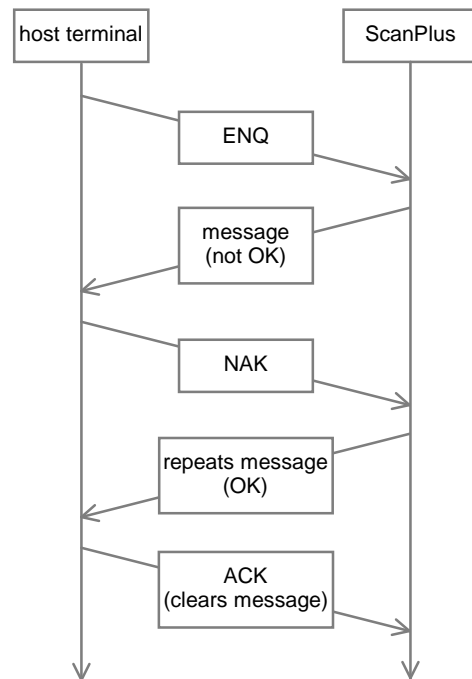
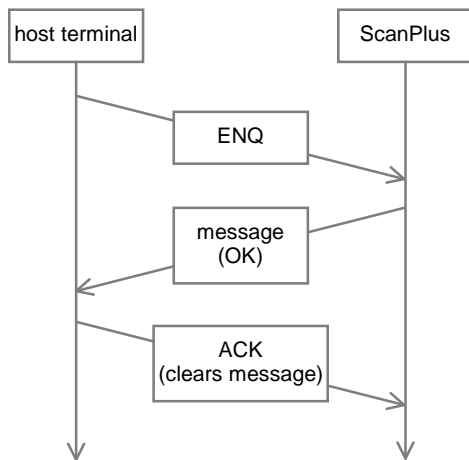

## RS-232

### XON/XOFF software protocol

This protocol allows the host to control the flow of data from the ScanPlus.  
To interrupt reception of data, the host transmits the XOFF character (ASCII DC3). To restart the flow, it sends the XON character (ASCII DC1).



### CTS/RTS hardware protocol

The ScanPlus acts as a standard terminal and manages the RTS/CTS lines when configured.  
RTS is activated (high) before data is transmitted and deactivated (low) when message transmission is completed.  
CTS is tested before transmission of each character. Data is only transmitted when CTS is activated (high). If CTS is not used by the host system, the ScanPlus maintains the level high.



### LRC (Longitudinal Redundancy Check)

LRC allows the exclusive OR of each character in the data. The result is converted into two bytes which can then be transmitted after the data.  
 Example LRC = 4Ah -> LRC1 = 34h, LRC2 = 41h



### Time-out (hardware and software)



### Compose time-out

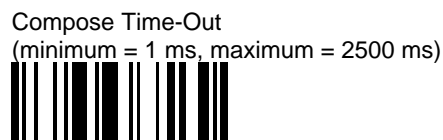

Example To set a hardware and software timeout of 2 seconds (= 2000 ms):

1. Scan Compose Time-Out.
2. Scan the desired value in milliseconds—in our example we would scan 2 0 0 0 (→ *Number codes* or inside back cover of this manual).
3. Scan End Selection to finish.

## RS-232

### Preamble / postamble

The ScanPlus can send preambles and postambles—control codes before and after each message—to emulate command keys on the keyboard and allow automatic data entry:

*<preamble> <barcode data> <postamble>*

Maximum number of characters in each preamble and postamble:

ScanPlus SP: maximum = 5 characters

ScanPlus ER / XP / PDF: maximum = 10 characters.

Preambles can contain customizable barcode type code marks ( → *Code mark*).

### No preamble / postamble



### Compose preamble / postamble

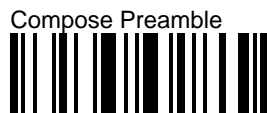

- Example To enter the STX character (ASCII character 02) as a preamble:
1. Scan Compose Preamble.
  2. Scan one or more character codes you want to include in the preamble—in our example we would scan the ASCII STX character code ( → *ASCII character codes* and *Keyboard wedge—Additional preamble / postamble characters*).
  3. Scan End Selection to finish.

**Predefined postamble codes**

Carriage Return + Line Feed (\*)



Carriage Return



Line Feed



**Transmission delay**

- *Inter-character delay*
- *Inter-message delay*

## RS-232—Slave mode

# RS-232—Slave mode

---

### Activation

Slave mode allows the ScanPlus to be configured or controlled directly by the terminal host via the RS-232 port.

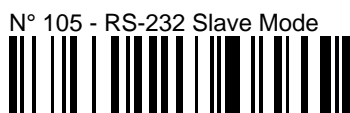

### How to use slave mode

#### 1. Activate slave mode

Scan the N° 105 - RS-232 Slave Mode code and reconfigure the standard RS-232 parameters to suit your system if required.

#### 2. Obtain the desired command strings

Put the ScanPlus into Display Data String Mode (→ *Configuration modes - Display data string mode*) and read the codes you want the host to transmit. The full data string (command and checksum) of each code you read is displayed on the terminal screen.

**Example**      Reading the Code 39 activation code in Display Data String Mode will display the data string:

\41\4C\60\5E

In this example, "\41\4C\60" is the command and "\5E" is the checksum.



## Scan rate parameters—ScanPlus SP

# Scan rate parameters—ScanPlus SP

---

Increasing the scan rate decreases the ability to decode high-density bar codes. Try to find the best scan-rate/density ratio for fast successful reading of your bar codes.

Use the scan rate / decode rate ratio codes on the next page to optimize your reading applications.

 **These codes are only for use with the ScanPlus SP—do not use these codes with other ScanPlus models (ER, XP, PDF, ...).**

### Predefined scan rates



## Scan rate parameters—ScanPlus SP

### Scan rate / decode rate ratio

 These codes are only for use with the ScanPlus SP—do not use these codes with other ScanPlus models (ER, XP, PDF, ...).

### Decode Rate = Scan Rate

Decode Rate = Scan Rate provides the best compromise between fast decoding and the maximum number of characters decoded at one time (maximum of 240 bars or spaces depending on the bar code format used):

- fastest decoding rate,
- limited number of elements in the barcode label (for example, Code 39 codes are limited to 23 characters maximum).

Decode Rate = Scan Rate (\*)



### Decode Rate = Scan Rate / 2

Decode Rate = Scan Rate / 2 increases the ScanPlus buffer size to store more barcode data but decreases the decoding rate:

- unlimited barcode length,
- slower decoding rate.

Decode Rate = Scan Rate / 2



## Software / CPU version identification

# Software / CPU version identification

---

## Software / CPU Versions

Software and CPU version information is useful if you have a problem and need to contact your UBI representative (→ *Troubleshooting*).



## Version indications

For recent ScanPlus models, Software / CPU Versions identifies the versions of the software and CPU installed as follows:

- textual display on the host terminal screen (if applicable),
- a sequence of beeps indicates the software version,
- a sequence of red reading LED flashes indicates the CPU version.

Older ScanPlus models may not provide all of the above version information.

## Textual display on the host terminal screen

If the ScanPlus is connected to a host terminal with a display monitor, the software and CPU versions are displayed on the screen.

Example      ScanPlus ER software version 3.7 and CPU version 1.5 is indicated by:  
                 \*ER 3.7 - CPU 1.50\*

## Software / CPU version identification

### Software version beeps

Each digit of the software version number (N.N) is indicated by a number of long beeps corresponding to (*version\_number* + 1).

The specific software version letter if applicable (n.nL) is represented by a number of short beeps corresponding to the equivalent alphabetical position of the letter.

Example	Specific software version 4.0A is indicated by: 5 long beeps a pause 1 long beep a pause 1 short beep
---------	--

### CPU version red LED flashes

Each digit of the main CPU version number (N.N) is indicated by a number of long beeps corresponding to (*version\_number* + 1).

The specific CPU version number if applicable (n.nN) is represented by a number of short beeps corresponding exactly to (*specific\_version\_number*).

Example	Specific CPU version 1.63 is indicated by: 2 long beeps a pause 7 long beeps a pause 3 short beeps
---------	---

## Symbologies

# Symbologies

---

### Available symbologies

Some symbologies such as Codablock and PDF417 are not available with all ScanPlus models—specific symbology availability is indicated with the symbology activation codes.

**To optimize the performance of your ScanPlus and to ensure trouble-free scanning, do not select symbologies that you do not need (→ *Symbologies—Activation*).**

- *Symbologies—Codabar*
- *Symbologies—Codablock*
- *Symbologies—Code 39*
- *Symbologies—Code 93*
- *Symbologies—Code 128 / EAN 128*
- *Symbologies—Interleaved 2 of 5*
- *Symbologies—Matrix 2 of 5*
- *Symbologies—MSI Code*
- *Symbologies—PDF417*
- *Symbologies—Plessey Code*
- *Symbologies—Standard 2 of 5*
- *Symbologies—UPC/EAN code families (UPC-A, UPC-E, EAN-8, EAN-13)*

### Default symbologies

Depending on your ScanPlus model, certain symbologies are already selected by default:

- ScanPlus SP / ER / XP - UPC/EAN Code Set, Code 39
- ScanPlus PDF - PDF417

### Character formats and ScanPlus transmission format

symbology	character format supported	ScanPlus transmission format
<ul style="list-style-type: none"> <li>Code 39</li> </ul>	alphanumeric—letter case not defined	upper case
<ul style="list-style-type: none"> <li>Code 93</li> <li>Code 128</li> <li>Codablock</li> <li>PDF417</li> </ul>	alphanumeric full ASCII—letter case defined	full ASCII—lower case/upper case as defined
<ul style="list-style-type: none"> <li>Codabar</li> <li>Interleaved 2 of 5</li> <li>Matrix 2 of 5,</li> <li>Standard 2 of 5</li> <li>UPC/EAN code set</li> </ul>	numerical	numerical

### Barcode length and data security

The reliability of the barcode data transmitted can depend on the symbologies used—some symbologies are more "fragile" than others and errors may occur due to incorrect interpretation of code lengths.

Depending on the symbology used, the following barcode length parameters allow you to configure the ScanPlus to only accept codes which meet certain length requirements:

- Compose 1 Or 2 Fixed Lengths—the safest option if you know that all the codes in your application have fixed lengths,
- Compose Minimum Length—if there are variable code lengths but you know that there is a minimum length,
- Any Length—the lowest level of security (use this option only if you can not use Compose 1 Or 2 Fixed Lengths or Compose Minimum Length).

## Symbologies

As well as barcode length parameters, other configuration parameters help to increase the security of the data transmitted (→ *Data decoding security parameters*).

If you use the Compose Minimum Length option, we recommend that you use a check digit (if available) and the *Consecutive same read data validation* feature (→ *Data decoding security parameters*) to ensure that the same read result is obtained on 2 or more successive reads before the read is validated.

Not all the barcode length parameters are available for all symbologies.



**Each symbology has a different set of configuration codes for barcode length parameters—you must only use the codes for your symbology.**

### Compose 1 Fixed Length

- Example      If the bar codes in your application have fixed lengths of 12 characters:
1. Use your ScanPlus to read the Compose 1 Or 2 Fixed Lengths bar code for your symbology.
  2. Enter the fixed length—12 in our example—by reading the appropriate number codes (→ *Number codes* or inside back cover of this manual).
  3. Scan End Selection.
  4. Scan End Selection a second time to finish.

### Compose 2 Fixed Lengths

- Example      If the bar codes in your application have fixed lengths of 8 and 12 characters:
1. Use your ScanPlus to read the Compose 1 Or 2 Fixed Lengths bar code for your symbology.
  2. Enter the first fixed length—8 in our example—by reading the appropriate number code (→ *Number codes* or inside back cover of this manual).
  3. Scan End Selection.
  4. Enter the second fixed length—in our example we would scan 1 then 2.
  5. Scan End Selection.
  6. Scan End Selection a second time to finish.

### Compose Minimum Length

- Example    If the bar codes in your application have a minimum length of 6 characters:
1. Use your ScanPlus to read the Compose Minimum Length bar code for your symbology.
  2. Enter the minimum length—6 in our example—by reading the appropriate number code (→ *Number codes* or inside back cover of this manual).
  3. Scan End Selection to finish.

## Symbologies—Activation

# Symbologies—Activation

---

**To optimize the performance of your ScanPlus and to ensure trouble-free scanning, do not select symbologies that you do not need.**

The Disable All Symbologies code deactivates all the symbologies activated. If you want to deactivate individual symbologies, use the Not Active codes for each symbology.

Disable All Symbologies does not reset the individual parameter settings for each symbology. When you reactivate a symbology, you recover the parameter settings stored in memory for that symbology when it was disabled.

If you want to reset all the individual symbology parameters to their factory default values, you must scan the Reset Factory Defaults bar code ( → *Reset all configuration parameters*).

**The symbology activation codes are also provided with the parameters for each symbology ( → appropriate *Symbologies* section for your symbology).**

### Codablock

Select the desired Codablock format and scan Codablock—Active to enable.

Codablock—Not Active (\*)

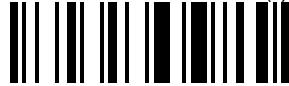

Codablock—Active  
(only available ScanPlus XP / PDF)



Codablock F (\*)



Codablock A



---

Disable All Symbologies



# Symbologies—Activation

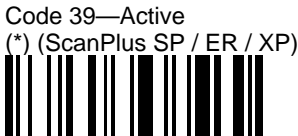
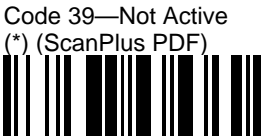

## Symbologies—Activation

Matrix 2 of 5—Not Active (\*)



Matrix 2 of 5—Active



MSI Code—Not Active (\*)



MSI Code—Active



PDF417—Not Active



PDF417—Active (\*)  
(only available ScanPlus PDF)



Plessey Code—Not Active (\*)



Plessey Code—Active



Standard 2 of 5—Not Active (\*)



Standard 2 of 5—Active



---

Disable All Symbologies



# Symbologies—Activation

## UPC/EAN code families

Select the desired UPC/EAN format configuration and scan UPC/EAN—Active to enable.

UPC/EAN—Not Active  
(\* (ScanPlus PDF)

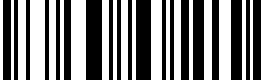

UPC/EAN—Active  
(\* (ScanPlus SP / ER / XP)

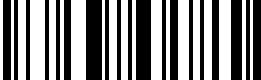

Reactivate All—UPC-A, UPC-E, EAN-8, EAN-13 (\*)

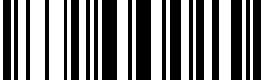

UPC-A Deactivated



UPC-E Deactivated



EAN-8 Deactivated



EAN-13 Deactivated



---

Disable All Symbologies



## Symbologies—Codabar

# Symbologies—Codabar

---

### Activation



### Default values

Start/stop bars	- Not Transmitted
CLSI library system	- Not Active
Check digit (AIM recommendation)	- Not Used
Number of characters	- Minimum Length = 6

## Symbologies—Codabar

### Start/stop

Not Transmitted (\*)

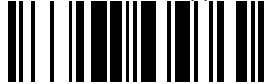

a, b, c, d

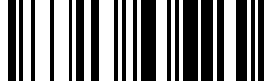

A, B, C, D



a, b, c, d / t, n, \*, e

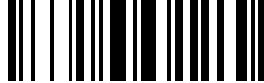

DC1, DC2, DC3, DC4



### CLSI library system

Libraries in the CLSI system used in the United States require the insertion of spaces within the 14-character label—for example, the label 39990000192148 is transmitted as 3 9990 00019 2148.

The start/stop code can be transmitted or not transmitted as required.

Not Active (\*)

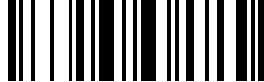

Active



## Symbologies—Codabar

### Check digit (AIM recommendation)

While Codabar has no check character, AIM has a recommended character. Each Codabar data character has a value assigned to it.



### AIM data character values

data character	value	data character	value
0	0	-	10
1	1	\$	11
2	2	:	12
3	3	/	13
4	4	,	14
5	5	+	15
6	6	A	16
7	7	B	17
8	8	C	18
9	9	D	19

## Symbologies—Codabar

### Calculation of the check digit

1. The values corresponding to all the Codabar data characters in the message (including Start/Stop characters) are added together to make a total.
2. The data character which must be added to this total to make a multiple of 16 is the check character.

Example	message:	A 0 1 2 3 4 B
	characters:	A 0 1 2 3 4 B
	values:	16 0 1 2 3 4 17
	sum of character values:	43
	next multiple of 16:	48
	48 - 43 =	5 (the check character)
	final message:	A 0 1 2 3 4 <b>5</b> B

## Symbologies—Codabar

### Barcode length

Barcode length (number of characters) for Codabar = [start + barcode data + check digit if applicable + stop]. The minimum length possible is 3 characters.

**For maximum security, we recommend that you use one of the following parameters with all ScanPlus products:**

- **Compose 1 or 2 Fixed Lengths (the safest configuration),**
- **Compose Minimum Length.**

 **The Any Length code provides zero security.**

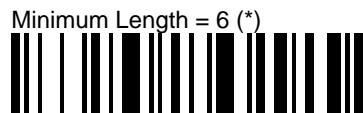

Compose different lengths using the special number codes (→ *Number codes* or inside back cover of this manual) and scan End Selection once or twice as required:

minimum length:	Compose Minimum Length <length>—End Selection
1 fixed length:	Compose 1 or 2 Fixed Lengths <length>— <b>End Selection—End Selection</b>
2 fixed lengths:	Compose 1 or 2 Fixed Lengths <first length>—End Selection <second length>— <b>End Selection—End Selection</b>

# Symbologies—Codablock

---

## Activation

Select the desired Codablock format and scan Active to enable.

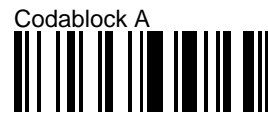
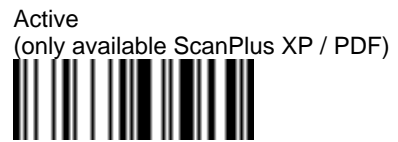

## Default values

- |                       |   |                 |
|-----------------------|---|-----------------|
| Codablock format      | - | Codablock F     |
| Timeout between reads | - | Active          |
| Check digit           | - | Not Transmitted |

## Symbologies—Codablock

### Time-out between reads



### Check digit



## Symbologies—Code 39

---

### Activation

Select the desired Code 39 format and scan Active to enable.

Full ASCII characters are encoded using one of the four control characters (\$, %, /, +) in combination with a letter ( → *Full ASCII conversion chart—Code 39* on the next page).

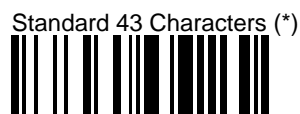

### Default values

Code 39 format	- Standard 43 Characters
Start/stop	- Not Transmitted
	- Active */* Only
Check digit	- Not Used
Number of characters	- Any Length

## Symbologies—Code 39

### Full ASCII conversion chart—Code 39

Code 39	ASCII	Hex	Code 39	ASCII	Hex	Code 39	ASCII	Hex	Code 39	ASCII	Hex
%U	NUL	00	Space	SP	20	%V	@	40	%W	'	60
\$A	SOH	01	/A	!	21	A	A	41	+A	a	61
\$B	STX	02	/B	"	22	B	B	42	+B	b	62
\$C	ETX	03	/C	#	23	C	C	43	+C	c	63
\$D	EOT	04	/\$	\$	24	D	D	44	+D	d	64
\$E	ENQ	05	/%	%	25	E	E	45	+E	e	65
\$F	ACK	06	/F	&	26	F	F	46	+F	f	66
\$G	BEL	07	/G	'	27	G	G	47	+G	g	67
\$H	BS	08	/H	(	28	H	H	48	+H	h	68
\$I	HT	09	/I	)	29	I	I	49	+I	i	69
\$J	LF	0A	/J	*	2A	J	J	4A	+J	j	6A
\$K	VT	0B	+ +	+	2B	K	K	4B	+K	k	6B
\$L	FF	0C	/L	,	2C	L	L	4C	+L	l	6C
\$M	CR	0D	/M	-	2D	M	M	4D	+M	m	6D
\$N	SO	0E	/N	.	2E	N	N	4E	+N	n	6E
\$O	SI	0F	/	/	2F	O	O	4F	+O	o	6F
\$P	DLE	10	0	0	30	P	P	50	+P	p	70
\$Q	DC1	11	1	1	31	Q	Q	51	+Q	q	71
\$R	DC2	12	2	2	32	R	R	52	+R	r	72
\$S	DC3	13	3	3	33	S	S	53	+S	s	73
\$T	DC4	14	4	4	34	T	T	54	+T	t	74
\$U	NAK	15	5	5	35	U	U	55	+U	u	75
\$V	SYN	16	6	6	36	V	V	56	+V	v	76
\$W	ETB	17	7	7	37	W	W	57	+W	w	77
\$X	CAN	18	8	8	38	X	X	58	+X	x	78
\$Y	EM	19	9	9	39	Y	Y	59	+Y	y	79
\$Z	SUB	1A	/Z	:	3A	Z	Z	5A	+Z	z	7A
%A	ESC	1B	%F	;	3B	%K	[	5B	%P	{	7B
%B	FS	1C	%G	<	3C	%L	\	5C	%Q		7C
%C	GS	1D	%H	=	3D	%M	]	5D	%R	}	7D
%D	RS	1E	%I	>	3E	%N	^	5E	%S	~	7E
%E	US	1F	%J	?	3F	%O	_	5F	%T	DEL	7F

# Symbologies—Code 39

## Start/stop

### Transmission



### Accepted characters



## Symbologies—Code 39

### Check digit

#### Deactivation



#### Modulo 43 check digit

The modulo 43 check digit is a character added to the end of the Code 39 bar code label for extra validation of the data.



#### French CIP check digit

The CIP check digit is used in the French pharmaceutical industry. It is only used for codes with seven characters.



#### Italian CPI check digit

The Italian CPI check digit is used in the Italian pharmaceutical industry. If the bar code 39 read does not match an Italian checksum, it is transmitted as a standard Code 39.



## Symbologies—Code 39

### Barcode length

Barcode length (number of characters) for Code 39 = [start + barcode data + check digit if applicable + stop]. The minimum length possible is 3 characters.

**If you know the minimum length of your bar codes, we recommend that you use the Compose Minimum Length parameter.**

**Compose Minimum Length is especially recommended for the ScanPlus ER.**

Any Length (\*)



Minimum Length = 6



Compose Minimum Length



Compose minimum length using the special number codes (→ *Number codes* or inside back cover of this manual) and scan End Selection:

minimum length: Compose Minimum Length  
<length>—End Selection

### Special wedge keys emulation

→ *Emulating special keyboard keys—Keyboard wedge - Special keys interpretation*

## Symbologies—Code 93

# Symbologies—Code 93

---

### Activation



### Default values

Number of characters - Any Length

## Symbologies—Code 93

### Barcode length

Barcode length (number of characters) for Code 93 = [barcode data]. The minimum length possible is 1 character.

**If you know the minimum length of your bar codes, we recommend that you use the Compose Minimum Length parameter.**

Any Length (\*)



Minimum Length = 6



Compose Minimum Length



Compose minimum length using the special number codes (→ *Number codes* or inside back cover of this manual) and scan End Selection:

minimum length: Compose Minimum Length  
<length>—End Selection

## Symbologies—Code 128 / EAN 128

# Symbologies—Code 128 / EAN 128

---

New normalization allows decoding of the UCC/EAN standard extension. EAN 128 is auto-discriminating with Code 128 (recognition of the FNC1 start character used).

### Activation

Not Active (\*)



Active



### Default values

- |  |                                    |
|--|------------------------------------|
| Number of characters                       | - Any Length                       |
| FNC1 separator character for EAN-128 norms | - GS function character (ASCII 29) |

## Symbologies—Code 128 / EAN 128

### Barcode length

Barcode length (number of characters) for Code 128 / EAN 128 = [barcode data]. The minimum length possible is 1 character.

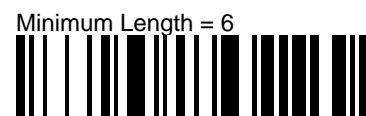
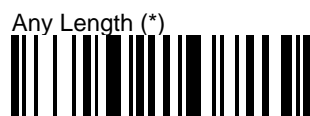

Compose minimum length using the special number codes (→ *Number codes* or inside back cover of this manual) and scan End Selection:

minimum length: Compose Minimum Length  
<length>—End Selection

## Symbologies—Code 128 / EAN 128

### Code EAN-128 norms (auto-discriminating)

#### Compose FNC1 separator character

Inside the code, the FNC1 character can be used as a separator when multiple identifiers and their fields are concatenated. It is transmitted as the GS function character (ASCII 29) by default and can be substituted by your own ASCII character (used for example for keyboard wedge interfaces where the GS character can not be transmitted).

Compose Other Character  
(default = GS, ASCII character 29)



**Example** If you want to use SP (ASCII character 32) as FNC1 separator character:

1. Use your ScanPlus to read the Compose Other Character bar code.
2. Scan the desired ASCII character and scan End Selection ( → *ASCII character codes*).

Symbologies—EAN-8, EAN-13

## **Symbologies—EAN-8, EAN-13**

---

→ *Symbologies—UPC/EAN code families (UPC-A, UPC-E, EAN-8, EAN-13)*

Symbologies—EAN 128

## Symbologies—EAN 128

---

→ *Symbologies—Code 128 / EAN 128*

## Symbologies—Interleaved 2 of 5

---

### Activation



### Default values

- Check digit - Not used
- Number of characters - Minimum Length = 6

## Symbologies—Interleaved 2 of 5

### Check digit

The Interleaved 2 of 5 check digit can be used as the last encoded character of a label. This is especially recommended when using variable length Interleaved 2 of 5 and if the *Consecutive same read data validation* feature is not activated (→ *Data decoding security parameters*).

Not Used (\*)



### Check digit mod 10

Checked And Transmitted



Checked But Not Transmitted



### French CIP HR check digit

The CIP HR check digit is used in the French pharmaceutical industry. It is only used for codes with seven characters.

Checked And Transmitted



Checked But Not Transmitted



## Symbologies—Interleaved 2 of 5

### Barcode length

Barcode length (number of characters) for Interleaved 2 of 5 = [barcode data + check digit if applicable]. The minimum length possible is 2 characters.

Interleaved 2 of 5 always encodes an even number of characters. To handle codes with an odd number of characters, the ScanPlus will accept a code with the last character printed as 5 narrow bars. In this case, all useful characters are transmitted.

**For maximum security, we strongly recommend that you use one of the following parameters with all ScanPlus products:**

- **Compose 1 or 2 Fixed Lengths (the safest configuration),**
- **Compose Minimum Length.**

 **The Any Length code provides zero security.**

Minimum Length = 6 (\*)



Any Length



Compose Minimum Length



Compose 1 or 2 Fixed Lengths



Compose different lengths using the special number codes (→ *Number codes* or inside back cover of this manual) and scan End Selection once or twice as required:

minimum length: Compose Minimum Length  
<length>—End Selection

1 fixed length: Compose 1 or 2 Fixed Lengths  
<length>—**End Selection—End Selection**

2 fixed lengths: Compose 1 or 2 Fixed Lengths  
<first length>—End Selection  
<second length>—**End Selection—End Selection**

## Symbologies—Matrix 2 of 5

# Symbologies—Matrix 2 of 5

---

### Activation



### Default values

Number of characters - Minimum Length = 6

## Symbologies—Matrix 2 of 5

### Barcode length

Barcode length (number of characters) for Matrix 2 of 5 = [barcode data]. The minimum length possible is 3 characters.

**For maximum security, we recommend that you use the Compose Minimum Length parameter with all ScanPlus products.**

 **The Any Length code provides zero security.**

Minimum Length = 6 (\*)



Any Length



Compose Minimum Length



Compose minimum length using the special number codes (→ *Number codes* or inside back cover of this manual) and scan End Selection:

minimum length: Compose Minimum Length  
<length>—End Selection

## Symbologies—MSI Code

# Symbologies—MSI Code

---

### Activation

Not Active (\*)



Active



### Default values

- Check digit mod 10 - Checked And Transmitted
- Number of characters - Minimum Length = 6

### Check digit

#### Check Digit Mod 10

Checked And Transmitted (\*)



Checked But Not Transmitted



#### Check Digit Double Mod 10

Checked And Transmitted



Checked But Not Transmitted



## Symbologies—MSI Code

### Barcode length

Barcode length (number of characters) for MSI Code = [barcode data + check digit]. The minimum length possible is 2 characters.

**For maximum security, we recommend that you use the Compose Minimum Length parameter with all ScanPlus products.**

 **The Any Length code provides zero security.**

Minimum Length = 6 (\*)



Any Length



Compose Minimum Length



Compose minimum length using the special number codes (→ *Number codes* or inside back cover of this manual) and scan End Selection:

minimum length: Compose Minimum Length  
<length>—End Selection

Symbologies—PDF417

## Symbologies—PDF417

---

### Activation



# Symbologies—Plessey Code

---

## Activation



## Default values

- Check digit - Not Transmitted
- Number of characters - Any Length

## Check digit



## Symbologies—Plessey Code

### Barcode length

Barcode length (number of characters) for Plessey Code = [start + barcode data + 2-character check digit + stop]. The minimum length possible is 5 characters. The maximum length possible is 25 characters.

**If you know the minimum length of your bar codes, we recommend that you use the Compose Minimum Length parameter.**

Any Length (\*)



Minimum Length = 6



Compose Minimum Length



Compose minimum length using the special number codes (→ *Number codes* or inside back cover of this manual) and scan End Selection:

minimum length: Compose Minimum Length  
<length>—End Selection

## Symbologies—Standard 2 of 5

---

Standard 2 of 5 is also referred to as "Straight 2 of 5" and "Industrial 2 of 5".

### Activation

Select the desired Standard 2 of 5 format and scan Active to enable.

Not Active (\*)



Active



Identicon (6 Start/Stop Bars) (\*)



Computer Identics (4 Start/Stop Bars)



### Default values

- Standard 2 of 5 format - Identicon (6 start/stop Bars)
- Check digit - Not Used
- Number of characters - Minimum Length = 6

## Symbologies—Standard 2 of 5

### Check digit mod 10

Not Used (\*)



Checked And Transmitted



Checked But Not Transmitted



## Symbologies—Standard 2 of 5

### Barcode length

Barcode length (number of characters) for Standard 2 of 5 = [barcode data + check digit if applicable]. The minimum length possible is 3 characters.

**For maximum security, we strongly recommend that you use one of the following parameters with all ScanPlus products:**

- **Compose 1 or 2 Fixed Lengths (the safest configuration),**
- **Compose Minimum Length.**

 **The Any Length code provides zero security.**

Minimum Length = 6 (\*)



Any Length



Compose Minimum Length

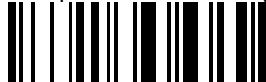

Compose 1 or 2 Fixed Lengths



Compose different lengths using the special number codes (→ *Number codes* or inside back cover of this manual) and scan End Selection once or twice as required:

minimum length:	Compose Minimum Length <length>—End Selection
1 fixed length:	Compose 1 or 2 Fixed Lengths <length>— <b>End Selection—End Selection</b>
2 fixed lengths:	Compose 1 or 2 Fixed Lengths <first length>—End Selection <second length>— <b>End Selection—End Selection</b>

## Symbologies—UPC/EAN code families

# Symbologies—UPC/EAN code families

## UPC-A, UPC-E, EAN-8, EAN-13

---

### Activation

Select the desired UPC/EAN format configuration and scan Active—UPC/EAN to enable.

To reactivate a deactivated family, you must reactivate all the families by scanning Reactivate All—UPC-A, UPC-E, EAN-8, EAN-13.

In the case of an unregular UPC-E with number system equal to 1—usually the first printed character—you must deactivate EAN-13 format.

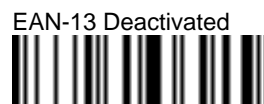
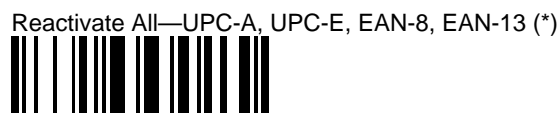

## Symbologies—UPC/EAN code families

### Default values

UPC/EAN format type	- all formats active (UPC-A, UPC-E, EAN-8, EAN-13)
Add-on digits	- Add-On 2 Deactivated - Add-On 5 Deactivated - Not Required But Transmitted If Read
Check digit UPC-A	- Transmitted
Check digit UPC-E	- Transmitted
Check digit EAN-8	- Transmitted
Check digit EAN-13	- Transmitted
UPC-A number system	- Transmitted
UPC-E number system	- Transmitted
Re-encoding UPC-E, UPC-A, EAN-8	- UPC-A Transmitted as EAN-13 - UPC-E Transmitted as UPC-E - EAN-8 Transmitted as EAN-8

## Symbologies—UPC/EAN code families

### Add-on digits

Not Required But Transmitted If Read (\*)

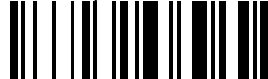

Required And Transmitted



### Add-On 2

Not Active (\*)



Active



### Add-On 5

Not Active (\*)



Active



## Symbologies—UPC/EAN code families

### Check digit

UPC/EAN code format: <leading character> <number system> <data> <check digit>

#### UPC-A check digit



#### UPC-E check digit



#### EAN-8 check digit



#### EAN-13 check digit



## Symbologies—UPC/EAN code families

### Transmission of number system

UPC/EAN code format: *<leading character>* *<number system>* *<data>* *<check digit>*

A regular UPC-A has a transmitted number system equal to 0. To transmit the additional leading character (country code), select the parameter UPC-A Transmitted As EAN-13.

### UPC-A number system

Transmitted (\*)



Not Transmitted



### UPC-E number system

Transmitted (\*)



Not Transmitted



## Symbologies—UPC/EAN code families

### Re-encoding UPC-A, UPC-E, EAN-8

These parameters convert the decoded data to other code formats. Transmission will only take into account the parameters available for the target bar code format.

UPC/EAN code format: *<leading character>* *<number system>* *<data>* *<check digit>*

A regular UPC-A has a transmitted number system equal to 0. To transmit the additional leading character (country code), select the parameter UPC-A Transmitted As EAN-13.

UPC-A Transmitted as EAN-13 (\*)



UPC-A Transmitted as UPC-A



UPC-E Transmitted as UPC-E (\*)



UPC-E Transmitted as UPC-A



EAN-8 Transmitted as EAN 8 (\*)



EAN-8 Transmitted as EAN-13



## Test codes

# Test codes

---

### One-dimensional symbologies

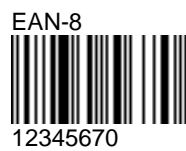

## Test codes

Standard 2 of 5



123456

Interleaved 2 of 5



12345678901234

Matrix 2 of 5



012345

## Two-dimensional symbologies

Codablock F

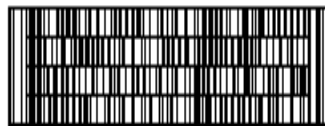

UBI ScanPlus XP and XP PDF  
CCD Bar Code Scanners

PDF417



UBI ScanPlus XP and XP PDF  
CCD Bar Code Scanners

## Troubleshooting

# Troubleshooting

---

The tables in this section describe some common problems you may encounter when you use your ScanPlus (power-up, normal operation, configuration). Look for a description of your problem in the *symptoms* columns and try the proposed solution given in the *action* column.

**If you can not solve the problem yourself, please contact your UBI representative.**

### Before you contact your UBI representative . . .

If you do not find a solution in the following *Troubleshooting* tables, you can try a general reset of the ScanPlus.

1. Make a list of your custom ScanPlus parameter settings if applicable.
2. Switch off the electrical supply to the ScanPlus—switch off the host system or disconnect the ScanPlus.
3. Position the ScanPlus over the Reset Factory Defaults code (➔ *Reset all configuration parameters*) and provide electrical power—switch on the host system or reconnect the ScanPlus.
4. Finish the general reset procedure as described in *Reset all configuration parameters*.

If you have a pushbutton model, press and hold the pushbutton when you perform step 3 and remember to activate the pushbutton after you have scanned Reset Factory Defaults.

### If you still have a problem . . .

Contact your UBI representative and give full details of the problem.

Your UBI representative may ask you to provide the software / CPU version numbers for your ScanPlus. If the ScanPlus is powered up, try to read the Software / CPU Versions code to display this information on your host system screen if applicable (➔ *Software / CPU version identification*).

### Power-up problems—all models

symptoms	possible causes	action (→ refer to)
no power-up beeps / green power-up LED	<ul style="list-style-type: none"> <li>no electrical power or insufficient electrical power</li> </ul>	check power supply
	<ul style="list-style-type: none"> <li>connection problems</li> </ul>	check connections ( <i>Connection diagram</i> for your interface)
	<ul style="list-style-type: none"> <li>incorrect product components (ScanPlus model, cables, external power supply as applicable)</li> </ul>	check product part numbers, order form and invoice + <i>Connection diagram</i> for your interface, <i>Interfaces</i>
	<ul style="list-style-type: none"> <li>power-up beep / LED deactivated</li> </ul>	activate power-up beep / LED ( <i>Beeps / green indicator LED</i> )
	<ul style="list-style-type: none"> <li>energy saver pushbutton model</li> </ul>	no action if pushbutton is activated—the power-up beeps and power-up LED are deactivated in Energy Saver mode and can not be activated ( <i>Pushbutton models</i> )
power-up beeps but no green LED flash at power-up	laser emulation interface selected	no action if your interface is laser emulation ( <i>Interfaces</i> )
green LED flashes a number of times at power-up	number of flashes indicate the selected interface type	<ul style="list-style-type: none"> <li>check the number of flashes for your interface (<i>Interfaces</i>)</li> <li>reselect correct interface number for your system if necessary (<i>Predefined interface numbers</i> section for your interface, <i>Compose interface number</i>) and reconfigure</li> </ul>
too many green LED flashes at power-up in spite of correct interface type selected	additional flash due to power surge at power-up	check that additional flash is at beginning and separate from other "normal" flashes (if applicable)
continuous green LED at power-up	null interface following Reset Factory Defaults	scan the predefined interface number code for your system ( <i>Predefined interface numbers</i> section for your interface) or enter the correct interface number ( <i>Compose interface number</i> ) and reconfigure
error beeps from keyboard when connecting ScanPlus	host system already switched on	wait a few seconds—the beeps should stop
3 long beeps at power-up	EEPROM hardware error	contact your UBI representative
3 long beeps then 5 short beeps at power-up	EEPROM integrity error	contact your UBI representative

## Troubleshooting

### Operating problems—all models

symptoms	possible causes	action (→ refer to)
no beeps or green indicator LED during reading, no transmission	<ul style="list-style-type: none"> <li>installation problem</li> </ul>	check ScanPlus power supply, connections ( <i>Connection</i> diagram for your interface), product components
	<ul style="list-style-type: none"> <li>configuration problem</li> </ul>	<ul style="list-style-type: none"> <li>check you have the correct product components (ScanPlus model, cables, CMM, external power supply as applicable)</li> <li>check you have the correct number of flashes for your interface at power-up (<i>Interfaces</i>)</li> <li>reselect correct interface number for your system if necessary (<i>Predefined interface numbers</i> section for your interface, <i>Compose interface number</i>)</li> <li>if you have just configured the ScanPlus, make sure you have finished correctly—the ScanPlus may be waiting for an End Selection for example</li> </ul>
	<ul style="list-style-type: none"> <li> symbology not selected</li> </ul>	activate the required symbology ( <i>Symbologies—Activation</i> )
	<ul style="list-style-type: none"> <li> symbology not supported by your ScanPlus model</li> </ul>	see the user's leaflet (if available) for your ScanPlus model, read the appropriate test code ( <i>Test codes</i> )
	<ul style="list-style-type: none"> <li> good read beep / LED deactivated</li> </ul>	activate if required ( <i>Beeps / green indicator LED</i> )
	<ul style="list-style-type: none"> <li> barcode length incompatible with ScanPlus configuration (minimum/fixed length parameter settings)</li> </ul>	<ul style="list-style-type: none"> <li>check bar code</li> <li>change barcode length setting for your symbology (<i>Symbologies</i>)</li> </ul>
	<ul style="list-style-type: none"> <li> ScanPlus configured for check digit and no check digit present in code</li> </ul>	<ul style="list-style-type: none"> <li>check bar code</li> <li>change check digit configuration for your symbology if applicable (<i>Symbologies</i>)</li> </ul>
	<ul style="list-style-type: none"> <li> you have read a pushbutton activation code with a non-pushbutton ScanPlus model</li> </ul>	perform the global reset procedure provided at the beginning of this section ( <i>Troubleshooting - Before you contact your UBI representative . . .</i> )

## Troubleshooting

error beeps from keyboard or no manual keyboard response (keyboard wedge interface)	disconnect ScanPlus from CMM:	
	<ul style="list-style-type: none"> <li>if problem disappears, the problem is with the ScanPlus</li> <li>if problem remains . . .</li> </ul>	<p>check ScanPlus model and configuration</p> <p>check all product components (ScanPlus model, cables, CMM, power supply as applicable), installation and configuration</p>
ScanPlus reads the same bar code more than once, transmits same data	insufficient time-out between identical consecutive codes	increase time-out between identical consecutive codes ( <i>Data decoding security parameters</i> )
ScanPlus transmits different data for the same bar code	<ul style="list-style-type: none"> <li>ScanPlus interprets part of the label as a different code (different symbology)</li> </ul>	scan Disable All Symbologies and only activate the symbologies you need ( <i>Symbologies—Activation</i> )
	<ul style="list-style-type: none"> <li>ScanPlus interprets part of the label as a separate code (smaller code inside the label)</li> </ul>	use the Compose 1 or 2 Fixed Lengths or Compose Minimum Length parameters if available ( <i>Symbologies - Barcode length and data security</i> and <i>Barcode Length</i> section for your symbology)
	<ul style="list-style-type: none"> <li>insufficient number of data validation reads (code damaged or poorly printed)</li> </ul>	increase number of consecutive same reads before transmission ( <i>Data decoding security parameters</i> )

### Operating problems—pushbutton models

symptoms	possible causes	action (→ refer to)
ScanPlus does not operate	pushbutton not pressed	press the pushbutton!
pushbutton does not operate	<ul style="list-style-type: none"> <li>pushbutton not activated (default configuration)</li> </ul>	activate the pushbutton for your ScanPlus model ( <i>Pushbutton models—Activation</i> )
	<ul style="list-style-type: none"> <li>pushbutton activation problem</li> </ul>	perform the global reset procedure provided at the beginning of this section ( <i>Troubleshooting - Before you contact your UBI representative . . .</i> )
no red aiming beam (standard pushbutton models)	aiming beam not activated	activate the aiming beam ( <i>Pushbutton models—Activation</i> )
ScanPlus does not flash with flashing mode activated	pushbutton activated	no action (flashing deactivated when pushbutton activated)

## Troubleshooting

### Configuration problems—all models

symptoms	possible causes	action (→ refer to)
6 short beeps when reading a configuration code	configuration error: <ul style="list-style-type: none"> <li>• option not available</li> <li>• interface number not available</li> <li>• optional feature not implemented</li> <li>• commands not read in the correct order</li> <li>• other setup errors</li> </ul>	check current action—make sure in particular that you have scanned End Selection once or twice if required for the previous parameter
no success beeps / green indicator LED when reading a configuration code	<ul style="list-style-type: none"> <li>• installation problem</li> </ul>	check ScanPlus power supply, connections ( <i>Connection</i> diagram for your interface), product components
	<ul style="list-style-type: none"> <li>• ScanPlus in Configuration Inhibit After 1 mn mode</li> </ul>	scan Configuration Enable ( <i>Configuration modes</i> )
code mark selection not taken into account	you forgot to scan End Selection after scanning the desired ASCII character	re-enter the desired code mark ( <i>Code mark</i> ) and scan End Selection ( <i>ASCII character codes</i> )
3 long beeps then 5 short beeps during configuration	EEPROM integrity error	contact your UBI representative
3 long beeps during configuration	EEPROM hardware error	contact your UBI representative

# Wand emulation

---

## Connection

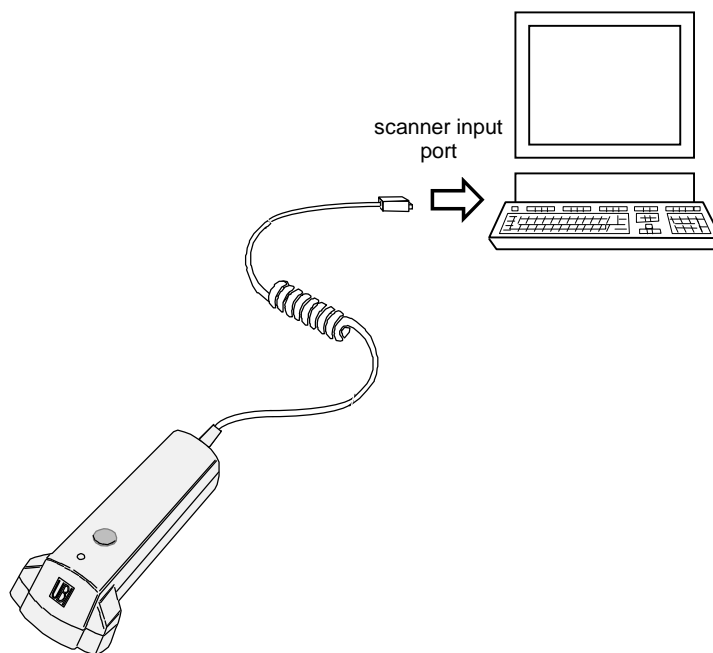

## Wand emulation

### Predefined interface numbers

If your interface number is not among the predefined interface numbers, you must compose the number yourself (→ *Compose interface number*).

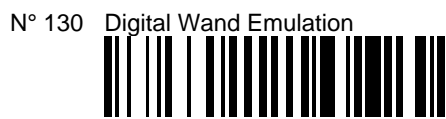

## Wand emulation

### Predefined data transmission settings

#### Predefined settings for Wand emulation - Interface N° 130

transmission code type	- original code
margin size	- 10 x narrow bar width
logical signal state during transmission	- bar = 1, space = 0, margin = 0
logical signal state outside transmission	- quiet zone = 0
pulse duration	- 0.88 ms (37.5 cm/s)

In this section, the predefined parameter settings for Interface N° 130 (standard wand emulation configuration) are indicated by an asterisk (\*).

## Wand emulation

### Transmitted symbology type

In wand emulation, the ScanPlus can transmit data in the original barcode format or converted into Code 39 format, provided that the bar codes contain characters that exist in the Code 39 standard.

Transmission In Original Code (\*)



Transmission In Code 39



Example To transmit Code 128 bar codes in Code 128 format:

- Scan Transmission In Original Code.

To transmit Code 128 bar codes in Code 39 format:

- Scan Transmission In Code 39.

### Transmission delay

→ *Inter-message delay*

## Wand emulation

### Margin size

#### Predefined margin size

The size of the default margin is 10 times the size of the narrow bar (50  $\mu$ s).

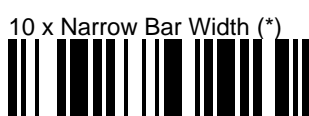

#### Compose margin size



- Example** To set a margin size of 20 x the narrow bar width:
1. Scan Compose Margin Size.
  2. Scan the desired value in narrow-bar increments—in our example we would scan 2 0 (→ *Number codes* or inside back cover of this manual).
  3. Scan End Selection to finish.

# Wand emulation

## Logical output signal state

### Signal state during transmission

Bar = 1, Space = 0, Margin = 0 (\*)

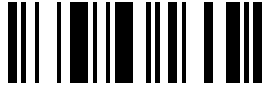

Bar = 0, Space = 1, Margin = 1



### Signal state outside transmission

Quiet Zone = 0 (\*)



Quiet Zone = 1

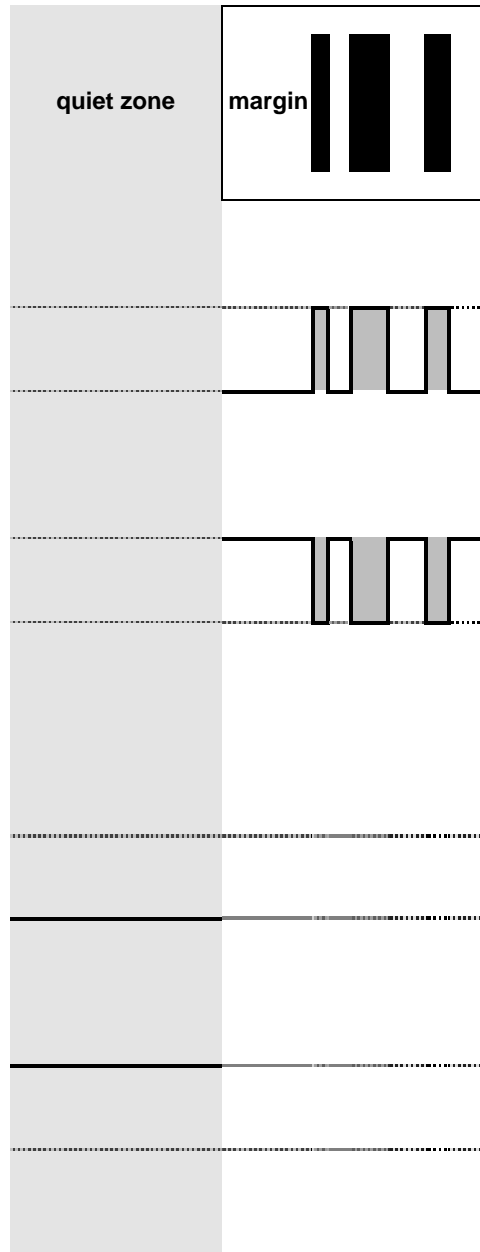

# Wand emulation

## Examples of signal state combinations

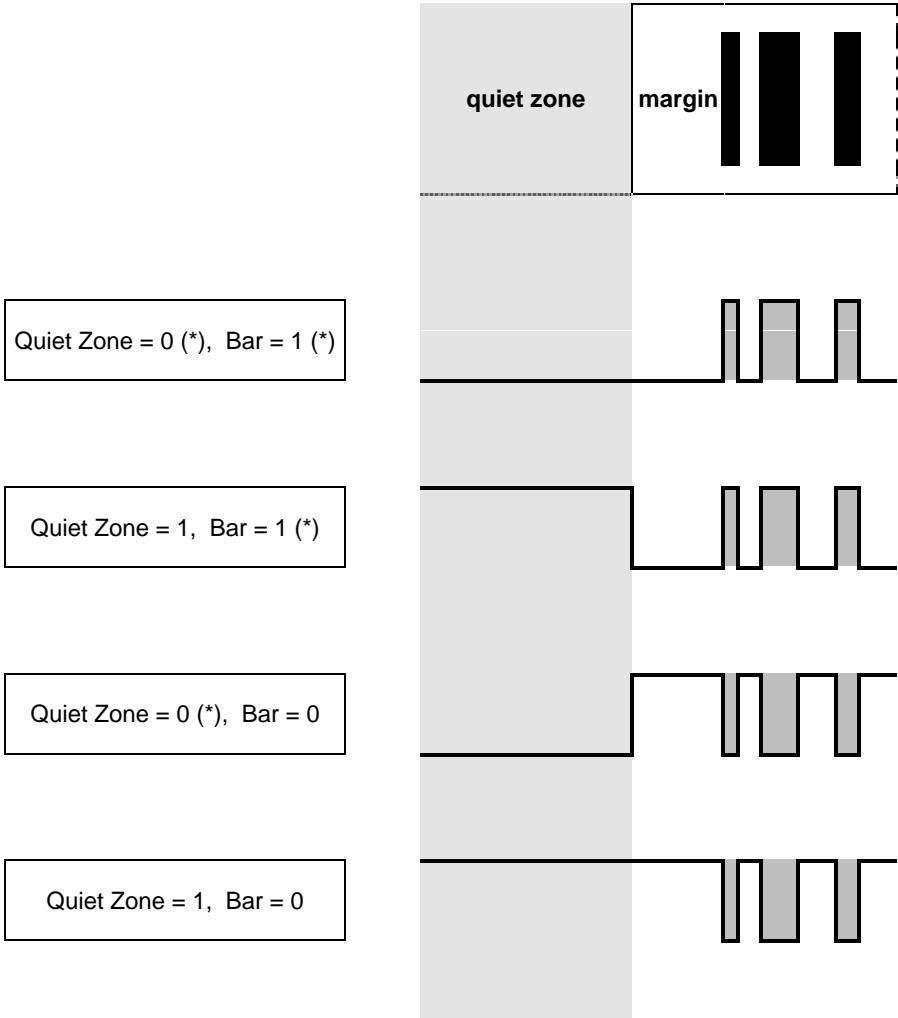

## Wand emulation

### Pulse duration

The values represent the pulse duration of a narrow bar or space.  
Speeds (values in parentheses) are provided for standard UPC/EAN bar codes with 0.33 mm narrow-bar elements.

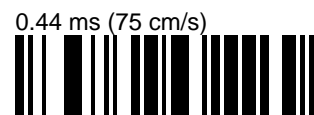
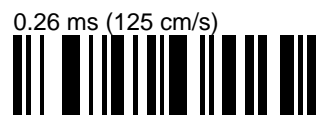
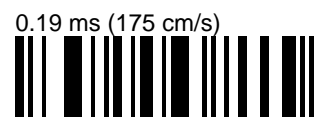

## Wand emulation

### Pulse duration speed calculation

Actual emulated speed = [  $100 \times ( r / t )$  ] cm/s

with  $r$  = actual narrowest element (mm)

$t$  = set-up duration element (ms)

Example	narrowest element (r):	0.45 mm
	set-up duration element (t):	0.4 ms
	emulated speed:	$100 \times (0.45 / 0.4) = 112.5$ cm/s



## Number codes



**UBI Inc. (USA)**

Ammendale Technology Park  
12240 Indian Creek Court  
Beltsville  
MD 20705  
USA

Tel: +1 301 210 3000  
Fax: +1 301 210 5498

**UBI Ltd (ENGLAND)**

Rubra 1  
The Mulberry Business Park  
Wokingham  
Berkshire RG112QJ  
ENGLAND

Tel: +44 1734 795636  
Fax: +44 1734 791851

**UBI International / UBI SA (FRANCE)**

Immeuble "Le Newton"  
23 avenue de l'Europe  
78402 CHATOU Cedex  
FRANCE

Tel: +33 1 30.15.25.35  
Fax: +33 1 34.80.14.33

**UBI SrL (ITALY)**

Via Speranza 35  
40068 San Lazzaro di Savena  
BOLOGNA  
ITALY

Tel: +39 51 453270  
Fax: +39 51 450460

**UBI GmbH (GERMANY)**

Max-Planck-Strasse 9-13  
D-85716 Unterschleissheim/München  
GERMANY

Tel: +49 89 32 18 10 0  
Fax: +49 89 32 18 10 20

**UBI Nordic (SWEDEN)**

Bredgatan 10  
222 21 LUND  
SWEDEN

Tel: +46 46 350 660  
Fax: +46 46 350 661

**UBI (DENMARK)**

Hovedvejen 122  
2600 GLOSTRUP  
DENMARK

Tel: +45 43 43 90 72  
Fax: +45 43 63 90 72

**UBI (NORWAY)**

Postboks 33  
1483 SKYTSTA  
NORWAY

Tel: +47 67 06 03 20  
Fax: +47 67 06 05 01

UBI representative: